

Complete Range of Products and Accessories to Create all Motor Starter Types

+ Short-Circuit Protection...

Type 1 or 2 coordination guaranteed between contactors and short-circuit protection devices (manual motor starters or fuses).

+ Comprehensive Range...

Connection accessories available for each type of wiring diagram or assembly.

+ Time/Cost Savings...

No cable preparation required and wiring time reduced.

+ Secure Connection...

No risk of fitting or wiring errors.

+ Simple Construction...

Easy assembly and fitting of products.

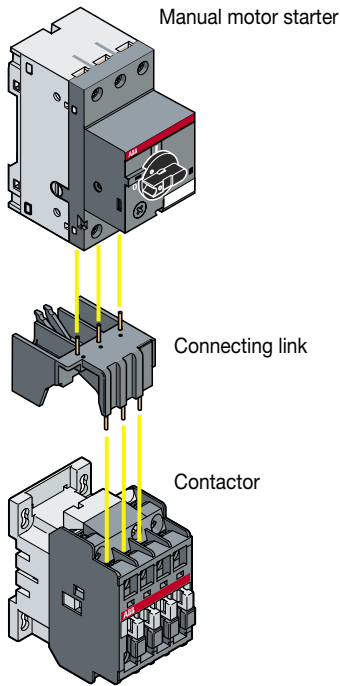

Direct-On-Line Starters

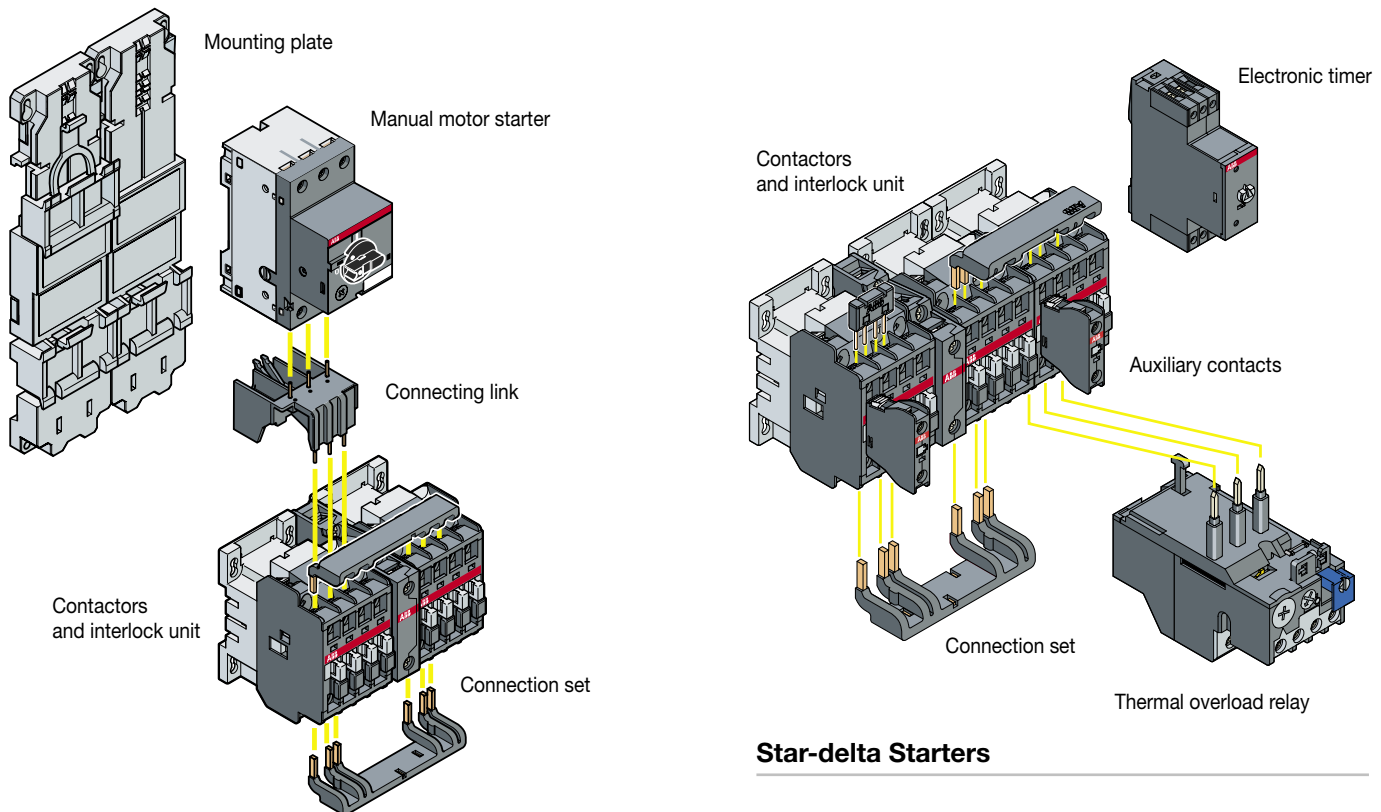

Star-delta Starters

Reversing Starters



Motor Starting Solutions

Open Type Version in Kit Form

Contents

General Information

Direct-On-Line Starting of 3-phase Asynchronous Motors	4
Star-Delta Starting of 3-phase Asynchronous Motors	5
Motor Rated Operational Powers and Currents	6
Utilization Categories	7
Coordination with Short-Circuit Protection Devices	8

Starters Protected by Manual Motor Starter

Direct-On-Line Starters	10
Reversing Starters	16
Wiring Diagrams	22
Dimensions	24

Starters Protected by Manual Motor Starter with Bus-bar System "smisline-S"

Direct-On-Line and Reversing Starters up to 11 kW	32
---	----

Starters Protected by Thermal Overload Relay

Direct-On-Line Starters	34
Reversing Starters	34
Star-Delta Starters without interlock unit	36
Star-Delta Starters with interlock unit	38
Wiring Diagrams	40
Dimensions	46

Accessories

Main Accessories	57
Connecting Links, Connection Sets and Mounting Plates for Direct-On-Line and Reversing Starters	58
Connection Sets for Star-Delta Starters	59

Coil Voltage and Thermal Overload Relay Codes

How to use the selection tables

Starters protected by manual motor starter

The tables page 10 up to 21 show for coordination type 1 and 2, the most usual combinations between MS.. manual motor starters and a.c. operated A.. contactors according to AC-3 motor powers, for Direct-On-Line and Reversing starters.

Select in the tables the MS.. manual motor starter, contactor and accessory codes necessary to assemble your starter.

To complete the code of the contactors, please see the table below.

Starters protected by thermal overload relay

The tables page 34 up to 39 show the most usual combinations between a.c. operated A.. contactors and TA..DU thermal overload relay according to AC-3 motor powers, for Direct-On-Line, Reversing or Star Delta starters.

Select in the tables the contactor, thermal overload relay and accessory codes necessary to assemble your starter.

For complete coordination tables type 1 and 2, see www.abb.com/lowvoltage and click on Online Product Selection Tools.

To complete the code of the contactors and the selected thermal overload relay, please see the tables below.

a.c. coil voltage code for completing contactor order codes

Voltage □□ V - 50Hz	Voltage □□ V - 60Hz	(1) Code □ □
24	24	8 1
26	28	1 6
28	32	1 7
42	42	8 2
42	48	2 0
48	48	8 3
60	60	7 3
100	100 ... 110	7 4
105	110 ... 127	2 6
110	110 ... 120	8 4
110 ... 115	115 ... 127	8 9
120	140	2 9
125 ... 127	150	3 0
175	208	3 4
190	220	3 6
210	240	4 0
220 ... 230	230 ... 240	8 0
230 ... 240	240 ... 260	8 8
230 ... 240	277	4 2
380 ... 400	400 ... 415	8 5
400 ... 415	415 ... 440	8 6
400	440	5 0
400 ... 415	480	5 1
415 ... 440	440 ... 460	8 7
440	500	5 3
500	600	5 5
550	-	5 6
660 ... 690	-	5 8
-	690	5 9

(1) Code in bold for dual frequency coils.

Setting Range for completing thermal overload relay order codes

Setting range A	Type TA 25 DU □□□	Order code
0.1 ... 0.16	TA 25 DU 0.16	1SAZ 211 201 R1005
0.16 ... 0.25	TA 25 DU 0.25	1SAZ 211 201 R1009
0.25 ... 0.4	TA 25 DU 0.4	1SAZ 211 201 R1013
0.4 ... 0.63	TA 25 DU 0.63	1SAZ 211 201 R1017
0.63 ... 1.0	TA 25 DU 1.0	1SAZ 211 201 R1021
1.0 ... 1.4	TA 25 DU 1.4	1SAZ 211 201 R1023
1.3 ... 1.8	TA 25 DU 1.8	1SAZ 211 201 R1025
1.7 ... 2.4	TA 25 DU 2.4	1SAZ 211 201 R1028
2.2 ... 3.1	TA 25 DU 3.1	1SAZ 211 201 R1031
2.8 ... 4.0	TA 25 DU 4.0	1SAZ 211 201 R1033
3.5 ... 5.0	TA 25 DU 5.0	1SAZ 211 201 R1035
4.5 ... 6.5	TA 25 DU 6.5	1SAZ 211 201 R1038
6.0 ... 8.5	TA 25 DU 8.5	1SAZ 211 201 R1040
7.5 ... 11	TA 25 DU 11	1SAZ 211 201 R1043
10 ... 14	TA 25 DU 14	1SAZ 211 201 R1045
13 ... 19	TA 25 DU 19	1SAZ 211 201 R1047
18 ... 25	TA 25 DU 25	1SAZ 211 201 R1051
24 ... 32 (1)	TA 25 DU 32	1SAZ 211 201 R1053
18 ... 25	TA 42 DU 25	1SAZ 311 201 R1001
22 ... 32	TA 42 DU 32	1SAZ 311 201 R1002
29 ... 42	TA 42 DU 42	1SAZ 311 201 R1003
18 ... 25	TA 75 DU 25	1SAZ 321 201 R1001
22 ... 32	TA 75 DU 32	1SAZ 321 201 R1002
29 ... 42	TA 75 DU 42	1SAZ 321 201 R1003
36 ... 52	TA 75 DU 52	1SAZ 321 201 R1004
45 ... 63	TA 75 DU 63	1SAZ 321 201 R1005
60 ... 80	TA 75 DU 80	1SAZ 321 201 R1006
29 ... 42	TA 80 DU 42	1SAZ 331 201 R1003
36 ... 52	TA 80 DU 52	1SAZ 331 201 R1004
45 ... 63	TA 80 DU 63	1SAZ 331 201 R1005
60 ... 80	TA 80 DU 80	1SAZ 331 201 R1006
65 ... 90	TA 110 DU 90	1SAZ 411 201 R1001
80 ... 110	TA 110 DU 110	1SAZ 411 201 R1002

(1) With terminal block DX 25: 1 x 16 mm²

General Information for Ordering

Ordering Details (examples)

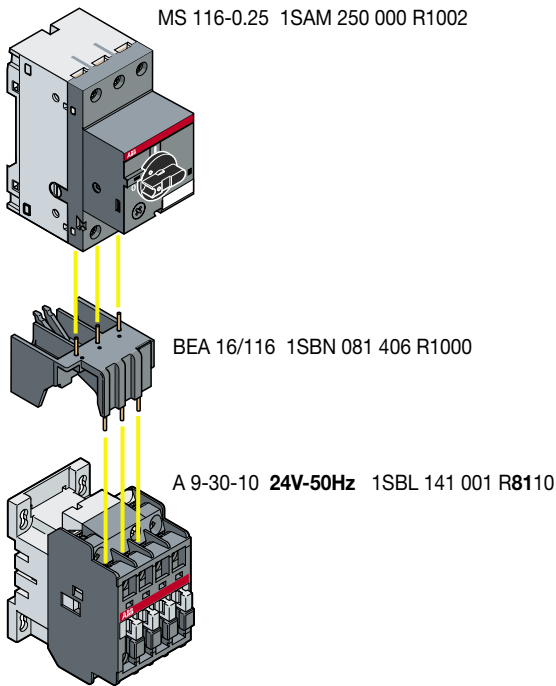

When placing an order, give either the **Order Code** or **Type** for all products to create motor starter.

According to the products, these are completed with: coil voltage for the contactors, setting range for the thermal O/L relays.

This is why the Order codes and Types figuring in the "Ordering Details" tables have boxes and to be completed.

Direct-On-Line Starters - Tables for ordering details, pages 12 ... 15

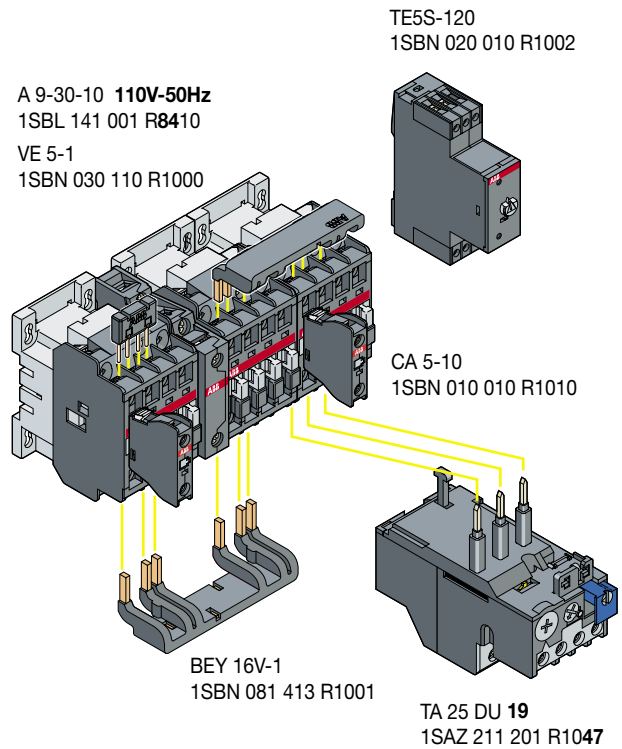
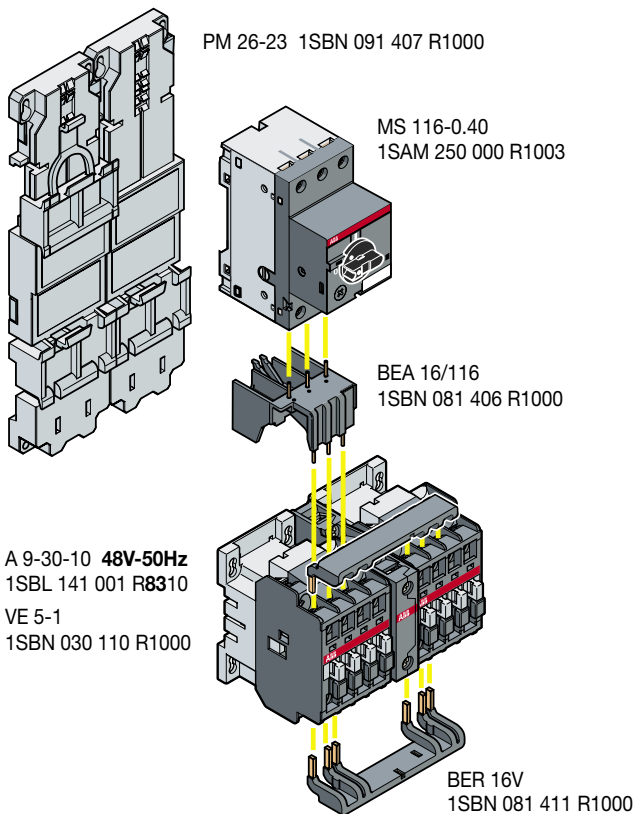

Star-Delta Starters

Tables for ordering details, pages 37, 39

Reversing Starters

Tables for ordering details, pages 18 ... 21

Motor Starting Solutions

Protection by Manual Motor Starter

Direct-On-Line Starters

Reversing Starters

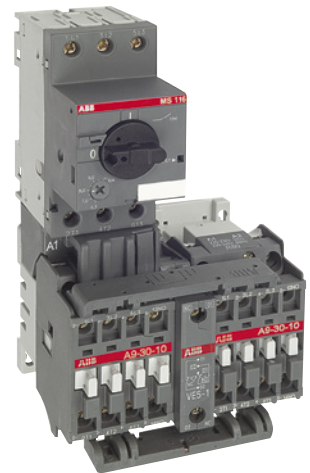

Rated Power - 400 V AC-3	0.06 kW ... 51 kW	0.06 kW ... 51 kW
Manual Motor Starters	MS 116 ... MS 495	MS 116 ... MS 495
Contactors	a.c. Operated Contactors A 9 ... A 110	a.c. Operated Contactors A 9 ... A 110
Connection Links	BEA 16/... BEA 110/495	BEA 16/... BEA 110/495
Connection Sets	-	BER 16... BEM 110/30

Protection by Thermal Overload Relay

Direct-On-Line Starters

Reversing Starters

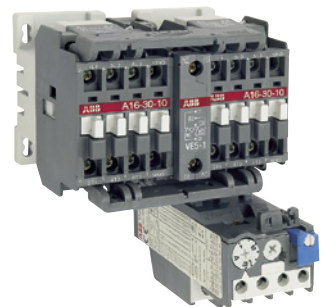

Rated Power - 400 V AC-3	4 kW ... 55 kW	4 kW ... 55 kW
Contactors	a.c. Operated Contactors A 9 ... A 110	a.c. Operated Contactors A 9 ... A 110
Thermal Overload Relays	TA 25 DU ... TA 110 DU	TA 25 DU ... TA 110 DU
Connection Sets	-	BER 16... BEM 110/30

Open Type Version in Kit Form

Direct-On-Line and Reversing Starters with Smisline System

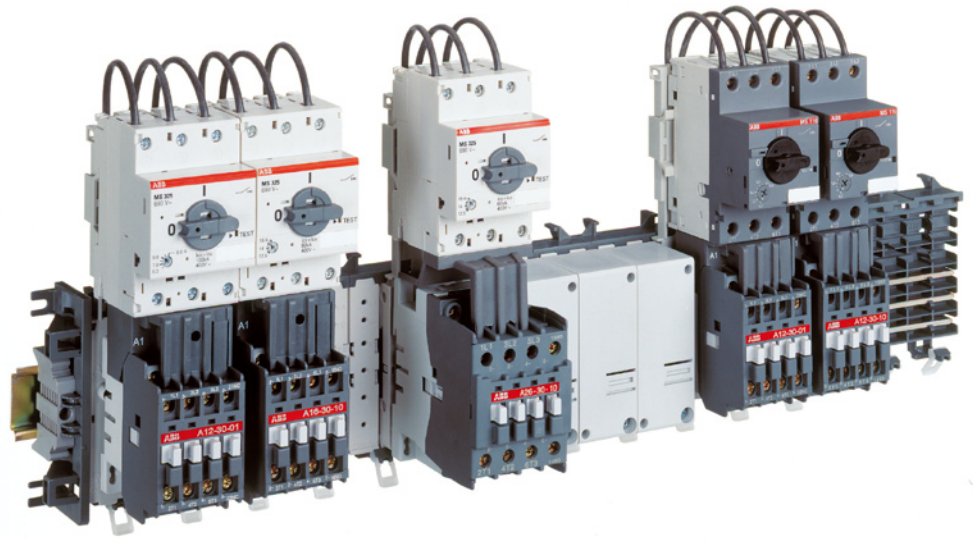

Rated Power - 400 V AC-3	0.06 kW ... 11 kW
Manual Motor Starters	MS 116 ... MS 325
Contactors	a.c. Operated Contactors A 9 ... A 26
Connection Accessories	BEA 16/... BEA 26/..., BER 16... BER 40..
Smisline Components	Combi-modul and Accessories

Star-Delta Starters

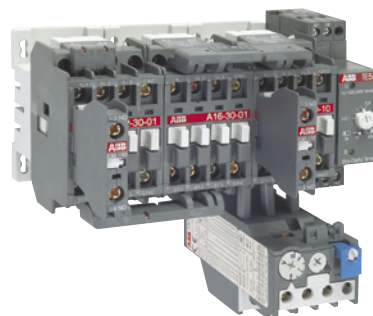

Rated Power - 400 V AC-3	7.5 kW ... 90 kW
Contactors	a.c. Operated Contactors A 9 ... A 110
Thermal Overload Relays	TA 25 DU ... TA 110 DU
Connection Sets	BEY 16 ... BED 110

General Information

Direct-On-Line Starting of Three-Phase Asynchronous Motors

General

A combination starter performs the following functions:

- circuit isolation and short-circuit protection,
- motor "ON" - "OFF" control,
- overload protection.

The isolation and short-circuit protection functions must be performed by a fuse isolator switch, a fuse switch or a circuit-breaker. Fuse ratings recommended in the coordination tables should be used. (A complete data base of coordination tables is available on the ABB Website.)

The «ON» - «OFF» control and overload protection functions are performed by a contactor and thermal overload relay combination. Full voltage Direct-On-Line starting is a simple, economic solution characterised by a high starting torque (1.9 to 2.1 times full-speed torque) and a starting current 5.5 to 7 times nominal current.

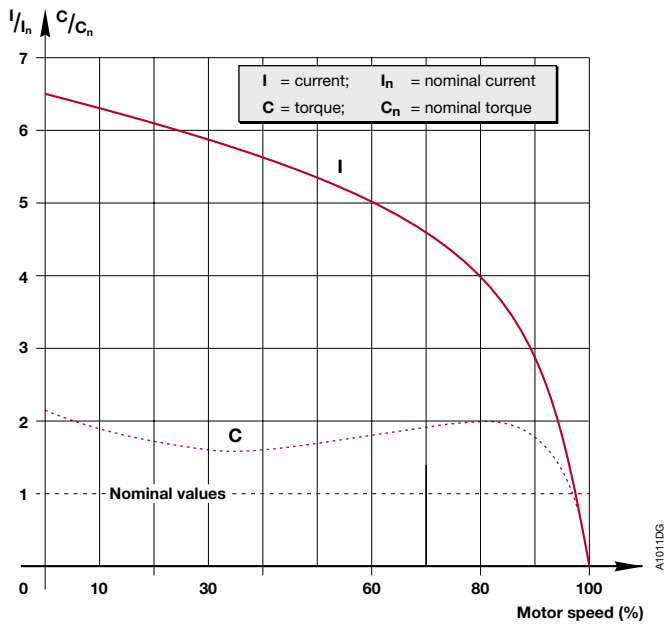

General Information

Star-Delta Starting of Three-Phase Asynchronous Motors

General

Star-delta starting is the most common method to reduce the starting current of a motor. This system can be used on all the squirrel cage motors, which are normally used in delta connection.

In this type of starting, it is recommended to choose motors having high starting torque i.e. much higher than the resistive torque in order to reach sufficient high speed when the motor is connected in star.

Star-Delta Starting

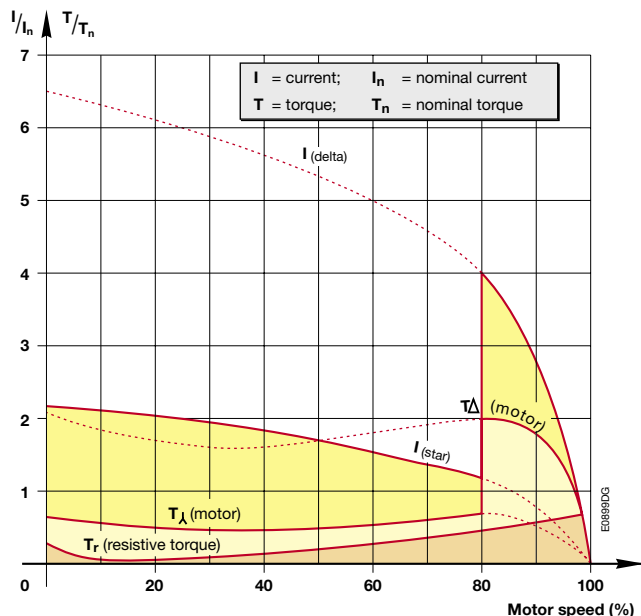

Technical Data

When starting:

- inrush current is reduced to a third of direct starting current,
- motor torque is reduced to a third or even less of direct starting torque.

Transient current is generated when switching from star to delta connection.

Utilization

During the initial starting phase («star» connection), the resistive torque of the driven load must remain, irrespective of speed, less than the «star» motor torque until «star-delta» switching occurs.

This starting mode is therefore ideal for machines having low starting torque such as:

- pumps,
- centrifugal compressors,
- wood-working machines, etc.

In order to prevent a high current peak, at least 85 % of nominal speed must be reached before switching from star to delta.

Precautions

Motor nominal voltage in delta connection must be equal to that of the mains.

Example: A motor for 400 V star-delta starting must be designed for 400 V in «delta» connection. Its usual designation is «400 V / 690 V motor». The motor must be constructed with 6 terminal windings.

Sequence

Starting is a three-stage process:

1st stage - «Star» connection - Press the «On» button on the control circuit to close the KM2 «star» contactor. The KM1 «line» contactor then closes and the motor starts. Countdown of programmed starting time (normally 6 to 10 s) then begins.

2nd stage - «Star» to «Delta» switching - When the programmed starting time is over, the KM2 «star» contactor opens.

3rd stage - «Delta» connection - A transition time (or dwelling time) of 50 ms is fixed between opening of the «star» contactor and closing of the «delta» contactor by the use of TE5S timer. This prevents short circuit between «star» and «delta».

Note:

When **AF...** contactor types are used as **delta** and **star** contactors or an **A...** contactor as **star** contactor with an **AF...** contactor as **delta** contactor, the use of a timer including a dwelling time (or transition time) e.g. TE5S is not recommended. A timer set for the starting duration in star connection is enough.

An electrical interlock between star and delta is mandatory such as VE 5 or through auxiliary contacts.

Furthermore, in open transition, the current interruption may reach up to 95 ms: it shall be checked that this duration is compatible with the application i.e. mainly if the decreasing in rotation speed is acceptable during the starting phase.

Maximum duty as per the chart on side.

(Switching frequency/hour, according to acceleration time and load factor).

Respect of the following conditions enables utilization of the starter without excessive overheating of the connections or nuisance tripping of the thermal O/L relay.

Example:

- Switching frequency = **15 starts/hr**
- Acceleration time "ta" = **7s** (use 8 s curve)
- Maximum load factor = **50 %**

This corresponds to a 4-minute operating cycle (15 starts/hr) with 7 seconds acceleration, 2 minutes operation and 2 minutes rest.

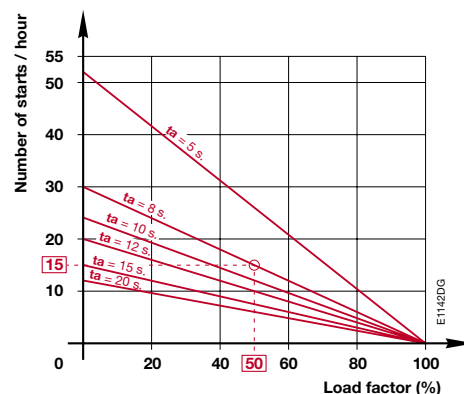

General Information

Motor Rated Operational Powers and Currents

The currents given below concern standard three-phase four-pole cage motors (1500 r.p.m. at 50 Hz, 1800 r.p.m. at 60 Hz). These values are given for guidance and may vary according to the motor manufacturer and depending on the number of poles.

IEC Motor power kW	Motor nominal current: standardized values in red colour (according to IEC 60947-4-1 Annex G)									
	220 V A	230 V A	240 V A	380V A	400 V A	415 V A	440 V A	500 V A	660 V A	690 V A
0.06	0.37	0.35	0.34	0.21	0.2	0.19	0.18	0.16	0.13	0.12
0.09	0.54	0.52	0.50	0.32	0.3	0.29	0.26	0.24	0.18	0.17
0.12	0.73	0.7	0.67	0.46	0.44	0.42	0.39	0.32	0.24	0.23
0.18	1	1	1	0.63	0.6	0.58	0.53	0.48	0.37	0.35
0.25	1.6	1.5	1.4	0.9	0.85	0.82	0.74	0.68	0.51	0.49
0.37	2.0	1.9	1.8	1.2	1.1	1.1	1.0	0.88	0.67	0.64
0.55	2.7	2.6	2.5	1.6	1.5	1.4	1.3	1.2	0.91	0.87
0.75	3.5	3.3	3.2	2.0	1.9	1.8	1.7	1.5	1.15	1.1
1.1	4.9	4.7	4.5	2.8	2.7	2.6	2.4	2.2	1.7	1.6
1.5	6.6	6.3	6.0	3.8	3.6	3.5	3.2	2.9	2.2	2.1
2.2	8.9	8.5	8.1	5.2	4.9	4.7	4.3	3.9	2.9	2.8
3	11.8	11.3	10.8	6.8	6.5	6.3	5.7	5.2	4.0	3.8
4	15.7	15	14.4	8.9	8.5	8.2	7.4	6.8	5.1	4.9
5.5	20.9	20	19.2	12.1	11.5	11.1	10.1	9.2	7.0	6.7
7.5	28.2	27	25.9	16.3	15.5	14.9	13.6	12.4	9.3	8.9
11	39.7	38	36.4	23.2	22	21.2	19.3	17.6	13.4	12.8
15	53.3	51	48.9	30.5	29	28.0	25.4	23	17.8	17
18.5	63.8	61	58.5	36.8	35	33.7	30.7	28	22.0	21
22	75.3	72	69	43.2	41	39.5	35.9	33	25.1	24
30	100	96	92	57.9	55	53	48.2	44	33.5	32
37	120	115	110	69	66	64	58	53	40.8	39
45	146	140	134	84	80	77	70	64	49.1	47
55	177	169	162	102	97	93	85	78	59.6	57
75	240	230	220	139	132	127	116	106	81	77
90	291	278	266	168	160	154	140	128	97	93
110	355	340	326	205	195	188	171	156	118	113
132	418	400	383	242	230	222	202	184	140	134
160	509	487	467	295	280	270	245	224	169	162
200	637	609	584	368	350	337	307	280	212	203
250	782	748	717	453	430	414	377	344	261	250
315	983	940	901	568	540	520	473	432	327	313
355	1109	1061	1017	642	610	588	535	488	370	354
400	1255	1200	1150	726	690	665	605	552	418	400
500	1545	1478	1416	895	850	819	745	680	515	493
560	1727	1652	1583	1000	950	916	832	760	576	551
630	1928	1844	1767	1116	1060	1022	929	848	643	615
710	2164	2070	1984	1253	1190	1147	1043	952	721	690
800	2446	2340	2243	1417	1346	1297	1179	1076	815	780
900	2760	2640	2530	1598	1518	1463	1330	1214	920	880
1000	3042	2910	2789	1761	1673	1613	1466	1339	1014	970

UL / CSA Motor power hp	Motor nominal current: standardized values (according to IEC 60947-4-1 Annex G and UL 508)				
	208 V A	220-240 V A	380-415 V A	440-480 V A	550-600 V A
1/2	2.4	2.2	1.3	1.1	0.9
3/4	3.5	3.2	1.8	1.6	1.3
1	4.6	4.2	2.3	2.1	1.7
1-1/2	6.6	6	3.3	3	2.4
2	7.5	6.8	4.3	3.4	2.7
3	10.6	9.6	6.1	4.8	3.9
5	16.7	15.2	9.7	7.6	6.1
7-1/2	24.2	22	14	11	9
10	30.8	28	18	14	11
15	46.2	42	27	21	17
20	59.4	54	34	27	22
25	74.8	68	44	34	27
30	88	80	51	40	32
40	114	104	66	52	41
50	143	130	83	65	52
60	169	154	103	77	62
75	211	192	128	96	77
100	273	248	165	124	99
125	343	312	208	156	125
150	396	360	240	180	144
200	528	480	320	240	192
250	-	604	403	302	242
300	-	722	482	361	289
350	-	828	560	414	336
400	-	954	636	477	382
450	-	1030	-	515	412
500	-	1180	786	590	472

General Information

Utilization Categories

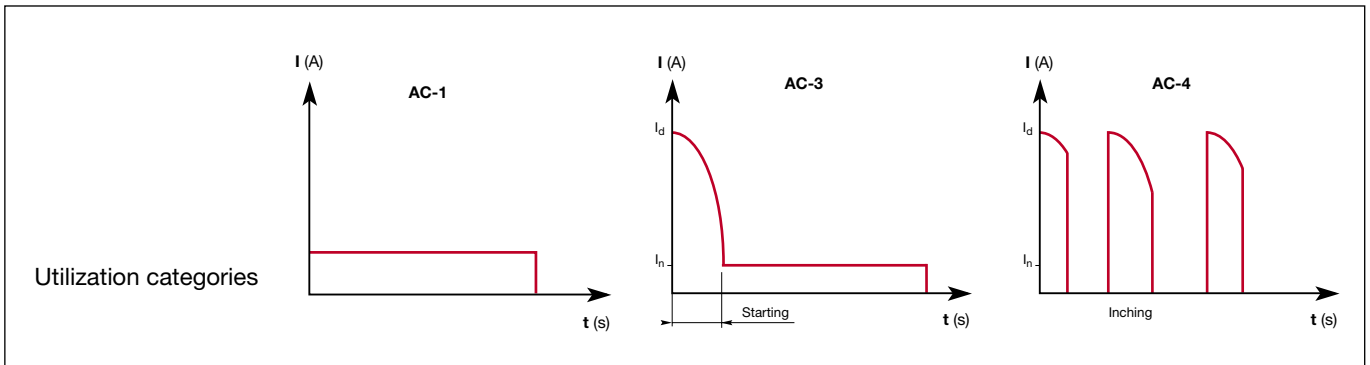

A contactor's duty is characterised by the utilization category together with the rated operational voltage and current indicated.

Utilization categories for contactors according to IEC 60947-4-1:

Alternating current

AC-1 Non-inductive or slightly inductive loads, resistance furnaces.

AC-2 Slip-ring motors: starting, switching off.

AC-3 Cage motors: starting, switching off running motors.

AC-4 Cage motors: starting, plugging, inching.

Making and Breaking Conditions for Utilization Categories

Utilization category	Durability test conditions						Occasional operation Making and Breaking Capacities - 50 operating cycles					
	Making conditions			Breaking conditions			Making conditions			Breaking conditions		
	I/I_e	U/U_e	Cos. φ or L/R (ms)	I/I_e	U/U_e	Cos. φ or L/R (ms)	I_c/I_e	U/U_e	Cos. φ or L/R (ms)	I_c/I_e	U/U_e	Cos. φ or L/R (ms)
AC-1	1	1	0.95	1	1	0.95	1.5	1.05	0.8	1.5	1.05	0.8
AC-2	2.5	1	0.65	2.5	1	0.65	4	1.05	0.65	4	1.05	0.65
AC-3 $I_e \leq 17$ A	6	1	0.65	1	0.17	0.65	10	1.05	0.45	8	1.05	0.45
AC-3 $17 < I_e \leq 100$ A	6	1	0.35	1	0.17	0.35	10	1.05	0.45	8	1.05	0.45
AC-3 $I_e > 100$ A	6	1	0.35	1	0.17	0.35	10	1.05	0.35	8	1.05	0.35
AC-4 $I_e \leq 17$ A	6	1	0.65	6	1	0.65	12	1.05	0.45	10	1.05	0.45
AC-4 $17 < I_e \leq 100$ A	6	1	0.35	6	1	0.35	12	1.05	0.45	10	1.05	0.45
AC-4 $I_e > 100$ A	6	1	0.35	6	1	0.35	12	1.05	0.35	10	1.05	0.35

Key:

U (I) = applied voltage (current)

U_r = recovery voltage

L/R = test circuit time constant

U_e (I_e) = rated operational voltage (current)

I_c = making and breaking current expressed in d.c. or in a.c. like the r.m.s. value of the symmetrical components

General Information

Coordination with Short-circuit Protection Devices

In compliance with standards IEC 60947-4-1 and EN 60947-4-1, we define for the contactors and starters the type, rating and characteristics of the short-circuit protection devices SCPD which allow selective protection against overloads and ensure protection against short circuits.

Basic Functions

Any starter is designed to:

- start motors,
- ensure continuous functioning of motors,
- disconnect motors from the supply line,
- guarantee protection of motors against overloads.

The starter is typically made up of a switching device (contactor) and an overload protection device (thermal overload relay TOR or electronic overload relay EOR).

These two devices **MUST** be coordinated with equipment capable of providing protection against short circuit (SCPD: short-circuit protective device): typically a circuit breaker with magnetic release only or a switch fuse. These are not necessarily part of the starter.

Applicable Standards

IEC 60947-4-1 (EN 60947-4-1) precisely defines the different points to be considered in order to carry out correct coordination.

Complete coordination for a combination includes the following points:

- Selectivity test between the overload relay and the short-circuit protection device SCPD.
- Short-circuit condition tests:
 - at prospective "r" currents - These currents depend on the rated operational current of the starter (I_e AC-3) and are given by the standard (Table 11). For example:
 - $r = 1\text{ kA}$ for I_e AC-3 < 16 A
 - $r = 3\text{ kA}$ for $16\text{ A} < I_e$ AC-3 < 63 A
 - $r = 5\text{ kA}$ for $63\text{ A} < I_e$ AC-3 < 125 A etc.
 - at the rated prospective short-circuit current " I_q " - This is the maximum current that the combination can withstand, for example 50 kA.

Types of Coordination

IEC 60947-4-1 (EN 60947-4-1) defines two types of coordination according to the expected level of service continuity. Acceptable extreme damage for the switchgear is divided into two types.

Type 1: In short-circuit conditions, the contactor or starter does not endanger persons or installations and will not be able to then operate without being repaired or having parts replaced.

Type 2: In short-circuit conditions, the contactor or starter does not endanger persons or installations and will be able to operate afterwards. The risk of contacts light welding is acceptable.

The Complete ABB Offer

ABB has acquired years of experience with respect to problems of coordination and is able to make a complete offer based on tests performed in its qualified laboratories. This offer includes 400 V, 500 V, 690 V networks.

A complete data base of coordination tables, according to IEC 60947-4-1 (EN 60947-4-1), is available on the ABB Website.

In the coordination tables, the following short-circuit protection devices are recommended:

- Moulded case circuit-breakers (MCCBs)
- Miniature circuit-breakers (MCBs)
- Switch-disconnector-fuses (aM, gG and BS)
- Manual Motor Starters (M.M.S.)

General Remarks Applicable to all Tables

- Each table is defined for a maximum ambient temperature of 40 °C. For higher temperatures, apply a derating factor according to the following rules:
 - Fuses: factor of 0.8 applied to I_n for an ambient temperature of 70 °C.
 - MCCBs and MCBs: factor of 0.8 applied to I_n for an ambient temperature of 60 °C.
 - The starter derating factor depends on the operating conditions of thermal overload relays:
 - Factor of 0.9 applied to I_n for an ambient temperature of 70 °C.
- Each table is defined for motor currents: 3-phase motors, 4-pole.
- **Normal starting** means a starting time < 2 s. - **Difficult starting** means an accelerating time $10\text{ s} < t_s < 30\text{ s}$.
 - Tripping classes** of thermal O/L relays according to IEC 60947-4-1 (EN 60947-4-1): 10 A and 10 for DU types and 30 for SU types.
- In the tables with MCCBs, these are fitted with the magnetic relay alone. Setting is always carried out at > 12.3 I_e AC-3 so that the transient current peak occurring during starting does not lead to tripping.

General Information

Coordination with Short-circuit Protection Devices

A motor starter is typically made up of a switching device (contactor) and an overload protection device (see opposite page "Basic Functions"). **These two devices MUST be coordinated with an equipment capable of providing protection against short-circuit (SCPD: Short-Circuit Protection Device).**

A complete data base of coordination tables, according to IEC 60947-4-1 (EN 60947-4-1), is available on the ABB Website: see www.abb.com/lowvoltage then go to the right menu: "Support", select: "Online Product Selection Tools".

Online Selected Optimized Coordination Tables

- [Introduction](#)
- [Instructions](#)
- [F.A.Q.](#)
- [Troubleshooting](#)

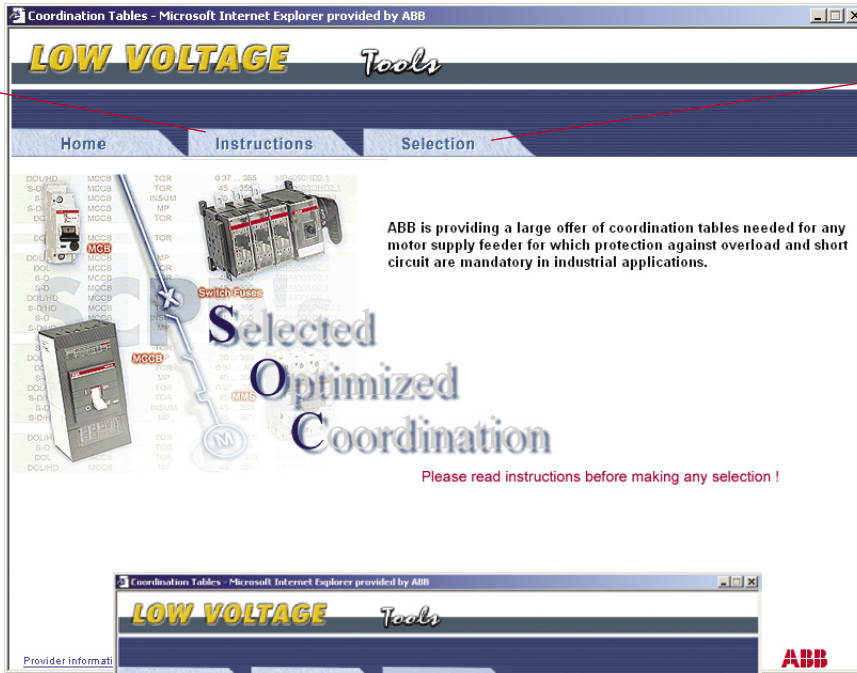

Short-Circuit Protection Device (SCPD) selection

Selection

- [Switch-disconnector-fuses \(aM and gG\)](#)
- [Miniature Circuit-Breakers \(MCBs\)](#)
- [Moulded Case Circuit-Breakers \(MCCBs\)](#)
- [Manual Motor Starters \(MMS\)](#)

Rated Output [kW]	Rated Cu [A]	Rated Power [kW]	Rated Current [A]
0.06	0.22	0.06	0.22
0.09	0.34	0.09	0.34
0.12	0.44	0.12	0.44
0.18	0.60	0.18	0.60
0.25	0.83	0.25	0.83
0.37	1.12	0.37	1.12
0.55	1.46	0.55	1.46
0.75	1.9	0.75	1.9
1.1	2.6	1.1	2.6
1.5	3.5	1.5	3.5
2.2	4.8	2.2	4.8
3	6.5	3	6.5
4	8.5	4	8.5
5.5	11.5	5.5	11.5
7.5	15	7.5	15
11	22	11	22

Rated Output [kW]	Rated Current [A]	Type	Fuse Rating gG-Fuse [kA]	Fuse Type and Size	Contactor Type	Overload Protection Device Type	Current setting range [A] at setting max for starter [g]	Max. Allowed Setting Current [A]	Table
0.37	1.1	OS 320_	4	GFAA 00H	AG	TA2SDU 1.4	1.0 - 1.4	1.4	EM30BNS002.2
0.37	1.1	OS 320_	3	GFAM 00AM	AG	TA2SDU 1.4	1.0 - 1.4	1.4	EM30BNS002.2
0.37	1.1	OS 320_	4	GFAA 00H	AG	DOFCB_	7	1.3	EM30BNS002.2
0.37	1.1	OS 320_	2	GFAM 00AM	AG	DOFCB_	7	1.4	EM30BNS002.2

Complete coordination tables are available for the **Short-Circuit Protection Device (SCPD)**, the **Contactor** and the **Overload Protection Device** according to the **Rated Operational Voltage U_n** , the **Rated Short-circuit Current I_n** , the **Coordination Type** (type 1 or 2) and the **Motor Power**.

www.abb.com/lowvoltage Online Selected Optimized Coordination Tables





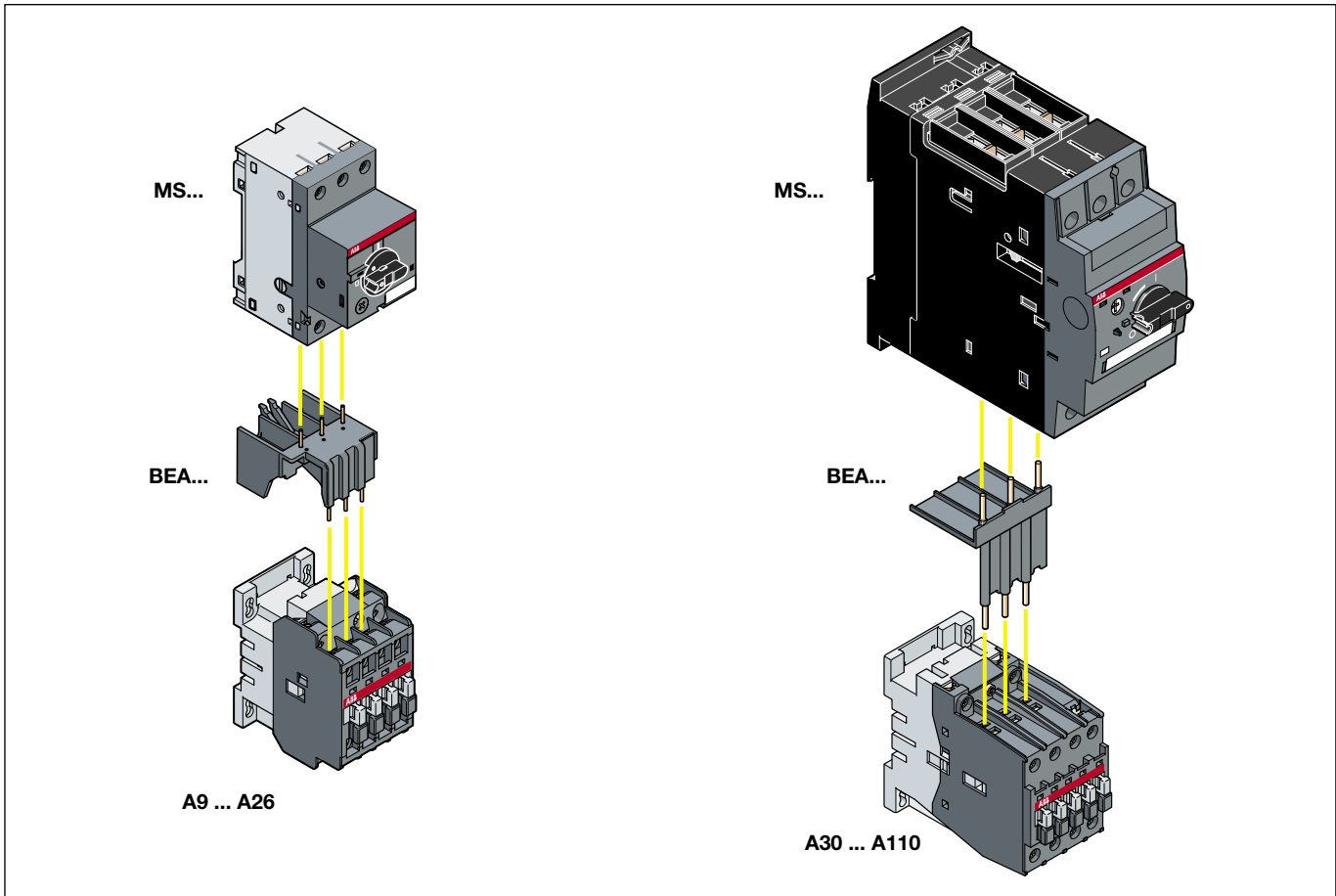

Direct-On-Line Starters Open Type Version, in Kit Form

Protected by Manual Motor Starter

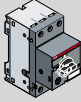
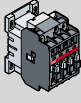

Selection Table

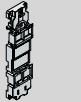
Manual motor starters																	
	MS 116				MS 325				MS 450				MS 495				
3-pole a.c. operated contactors																	
	A9	A12	A16	A26	A9	A12	A16	A26	A30	A40	A30	A40	A50	A63	A75	A95	A110
Connecting links																	
	BEA 16/116		BEA 26/116		BEA 16/325		BEA 26/325		BEA 40/450		BEA 50/450		BEA 75/495		BEA 110/495		
Mounting plate																	
	Not required		PM 26-13		Not required		PM 26-13										



Direct-On-Line Starters Open Type Version, in Kit Form

Protected by Manual Motor Starter



MS 116
+ BEA 16/116
+ A 9-30-10

Application

Direct-on-line starters for controlling three-phase asynchronous motors:

- up to an operational voltage of 415V - 50 or 60 Hz
- for a starting time of 1.5 s max.
 - and a switching frequency of ≤ 15 starts an hour with a load factor of 80%
 - ≤ 30 starts an hour with a load factor of 50%
- with an ambient temperature near the devices $< 50^{\circ}\text{C}$
- type 1 or type 2 coordination, complying with IEC 60947-4-1 / EN 60947-4-1

Coordination

In the event of a short-circuit, the starter is subjected to thermal stresses, in addition to very high electrodynamic stresses, proportional to short-current time.

The capacity to withstand these high stresses depends upon the perfect coordination of the devices which make up the starter.

The contactor and the manual motor starter control and protect motors against overload and short-circuits according to coordination types 1 and 2 defining the anticipated level of service continuity (Standard EN 60947-4-1 / IEC 60947-4-1).

The tables overleaf show, for each of the two coordination types, the most usual combination between the MS... manual motor starters and the contactors, according to AC-3 currents and motor powers for:

- coordination type 1 and type 2 at 400 V, 50 / 60 Hz, $I_q = 16$ kA
- coordination type 1 and type 2 at 400 V, 50 / 60 Hz, $I_q = 50$ kA.

Mounting and Connection Accessory Description

The BEA.. insulated 3-pole connecting link (touch safe) is used to electrically and mechanically connect the MS.. manual motor starter and the A... serie contactor.

This accessory eliminates the potential risk of wiring errors, reduces the time required to install, to test and to maintain a Direct-On-Line starter.

The PM26-13 mounting plate facilitates:

- the mounting and the dismounting of a A 26-30-.. up to A 40-30-.. contactor and its associated manual motor starter with the use of a BEA26/.. connecting link
- the simple snap fitting of the starter onto standard 35 mm rails within the control panel, or screw fitting onto the mounting plate.



Direct-On-Line Starters Protected by Manual Motor Starter

Coordination Type 1

Ordering Details - Coordination type 1, 400 V, 16 kA, 50/60 Hz

IEC		Manual Motor Starter			Contactor		Accessories	
Rated power kW	Rated current A	Type Order Code Unit piece	Current setting range A	Magnetic tripping current A	Type state coil voltage <input type="checkbox"/> <input type="checkbox"/> Order Code state coil voltage code <input type="checkbox"/> <input type="checkbox"/> Unit piece	Allowed Setting current A	Type Connecting link between MS.. and contactor	Fixing
0.06	0.22	MS116-0.25 1SAM 250 000 R1002	0.16 - 0.25	3	A9-30-10 <input type="checkbox"/> <input type="checkbox"/> 1SBL 141 001 R <input type="checkbox"/> <input type="checkbox"/> 10	0.25	BEA 16/116	on rail (1)
0.09	0.34	MS116-0.40 1SAM 250 000 R1003	0.25 - 0.40	4.8	A9-30-10 <input type="checkbox"/> <input type="checkbox"/> 1SBL 141 001 R <input type="checkbox"/> <input type="checkbox"/> 10	0.4	BEA 16/116	on rail (1)
0.12	0.44	MS116-0.63 1SAM 250 000 R1004	0.40 - 0.63	7.56	A9-30-10 <input type="checkbox"/> <input type="checkbox"/> 1SBL 141 001 R <input type="checkbox"/> <input type="checkbox"/> 10	0.63	BEA 16/116	on rail (1)
0.18	0.72	MS116-1.00 1SAM 250 000 R1005	0.63 - 1.00	12	A9-30-10 <input type="checkbox"/> <input type="checkbox"/> 1SBL 141 001 R <input type="checkbox"/> <input type="checkbox"/> 10	1	BEA 16/116	on rail (1)
0.25	0.83	MS116-1.00 1SAM 250 000 R1005	0.63 - 1.00	12	A9-30-10 <input type="checkbox"/> <input type="checkbox"/> 1SBL 141 001 R <input type="checkbox"/> <input type="checkbox"/> 10	1	BEA 16/116	on rail (1)
0.37	1.12	MS116-1.60 1SAM 250 000 R1006	1.00 - 1.60	19.2	A9-30-10 <input type="checkbox"/> <input type="checkbox"/> 1SBL 141 001 R <input type="checkbox"/> <input type="checkbox"/> 10	1.6	BEA 16/116	on rail (1)
0.55	1.45	MS116-1.60 1SAM 250 000 R1006	1.00 - 1.60	19.2	A9-30-10 <input type="checkbox"/> <input type="checkbox"/> 1SBL 141 001 R <input type="checkbox"/> <input type="checkbox"/> 10	1.6	BEA 16/116	on rail (1)
0.75	1.9	MS116-2.50 1SAM 250 000 R1007	1.60 - 2.50	30	A9-30-10 <input type="checkbox"/> <input type="checkbox"/> 1SBL 141 001 R <input type="checkbox"/> <input type="checkbox"/> 10	2.5	BEA 16/116	on rail (1)
1.1	2.59	MS116-4.00 1SAM 250 000 R1008	2.50 - 4.00	48	A9-30-10 <input type="checkbox"/> <input type="checkbox"/> 1SBL 141 001 R <input type="checkbox"/> <input type="checkbox"/> 10	4	BEA 16/116	on rail (1)
1.5	3.45	MS116-4.00 1SAM 250 000 R1008	2.50 - 4.00	48	A9-30-10 <input type="checkbox"/> <input type="checkbox"/> 1SBL 141 001 R <input type="checkbox"/> <input type="checkbox"/> 10	4	BEA 16/116	on rail (1)
2.2	4.8	MS116-6.30 1SAM 250 000 R1009	4.00 - 6.30	75.6	A9-30-10 <input type="checkbox"/> <input type="checkbox"/> 1SBL 141 001 R <input type="checkbox"/> <input type="checkbox"/> 10	6.3	BEA 16/116	on rail (1)
3	6.48	MS116-10.0 1SAM 250 000 R1010	6.30 - 10.0	120	A12-30-10 <input type="checkbox"/> <input type="checkbox"/> 1SBL 161 001 R <input type="checkbox"/> <input type="checkbox"/> 10	10	BEA 16/116	on rail (1)
4	8.6	MS116-10.0 1SAM 250 000 R1010	6.30 - 10.0	120	A12-30-10 <input type="checkbox"/> <input type="checkbox"/> 1SBL 161 001 R <input type="checkbox"/> <input type="checkbox"/> 10	10	BEA 16/116	on rail (1)
5.5	11.1	MS116-12.0 1SAM 250 000 R1012	8.00 - 12.0	144	A12-30-10 <input type="checkbox"/> <input type="checkbox"/> 1SBL 161 001 R <input type="checkbox"/> <input type="checkbox"/> 10	12	BEA 16/116	on rail (1)
7.5	14.8	MS116-16.0 1SAM 250 000 R1011	10.0 - 16.0	192	A16-30-10 <input type="checkbox"/> <input type="checkbox"/> 1SBL 181 001 R <input type="checkbox"/> <input type="checkbox"/> 10	16	BEA 16/116	on rail (1)

(1) No mounting plate required. MS.. can be fitted directly on a 35 mm rail.

Ordering Details - Main Accessories

Description	Type	Order Code	Packing pieces	Weight kg
Connecting links	BEA 16/116	1SBN 081 406 R1000	10	0.020
	BEA 16/325	1SBN 081 406 R1001	10	0.031
	BEA 26/325	1SBN 082 406 R1001	10	0.031
	BEA 40/450	1SBN 083 206 R1000	1	0.061
	BEA 50/450	1SBN 083 506 R1000	1	0.062
	BEA 75/495	1SBN 084 106 R1000	1	0.120
	BEA 110/495	1SBN 084 506 R1000	1	0.124
	Mounting plate	PM 26-13	1SBN 092 406 R1000	2

>> Coil Voltage Codespages 0/1, 0/2 in the Cover Flap
 >> Accessories, Ordering Details page 57
 >> Other Manual Motor Starters and Contactors Main Catalogue



Direct-On-Line Starters Protected by Manual Motor Starter

Coordination Type 1

Ordering Details - Coordination type 1, 400 V, 50 kA, 50/60 Hz

IEC		Manual Motor Starter			Contactor		Accessories	
Rated power kW	Rated current A	Type	Current setting range A	Magnetic tripping current A	Type	Allowed Setting current A	Type	Fixing
		Order Code			state coil voltage <input type="checkbox"/> <input type="checkbox"/> <input type="checkbox"/> <input type="checkbox"/>			
		Unit piece			state coil voltage code <input type="checkbox"/> <input type="checkbox"/>			
0.06	0.22	MS116-0.25 1SAM 250 000 R1002	0.16 - 0.25	3	A9-30-10 <input type="checkbox"/> <input type="checkbox"/> <input type="checkbox"/> <input type="checkbox"/> 1SBL 141 001 R <input type="checkbox"/> <input type="checkbox"/> 10	0.25	BEA 16/116	on rail (1)
0.09	0.34	MS116-0.40 1SAM 250 000 R1003	0.25 - 0.40	4.8	A9-30-10 <input type="checkbox"/> <input type="checkbox"/> <input type="checkbox"/> <input type="checkbox"/> 1SBL 141 001 R <input type="checkbox"/> <input type="checkbox"/> 10	0.4	BEA 16/116	on rail (1)
0.12	0.44	MS116-0.63 1SAM 250 000 R1004	0.40 - 0.63	7.56	A9-30-10 <input type="checkbox"/> <input type="checkbox"/> <input type="checkbox"/> <input type="checkbox"/> 1SBL 141 001 R <input type="checkbox"/> <input type="checkbox"/> 10	0.63	BEA 16/116	on rail (1)
0.18	0.72	MS116-1.00 1SAM 250 000 R1005	0.63 - 1.00	12	A9-30-10 <input type="checkbox"/> <input type="checkbox"/> <input type="checkbox"/> <input type="checkbox"/> 1SBL 141 001 R <input type="checkbox"/> <input type="checkbox"/> 10	1	BEA 16/116	on rail (1)
0.25	0.83	MS116-1.00 1SAM 250 000 R1005	0.63 - 1.00	12	A9-30-10 <input type="checkbox"/> <input type="checkbox"/> <input type="checkbox"/> <input type="checkbox"/> 1SBL 141 001 R <input type="checkbox"/> <input type="checkbox"/> 10	1	BEA 16/116	on rail (1)
0.37	1.12	MS116-1.60 1SAM 250 000 R1006	1.00 - 1.60	19.2	A9-30-10 <input type="checkbox"/> <input type="checkbox"/> <input type="checkbox"/> <input type="checkbox"/> 1SBL 141 001 R <input type="checkbox"/> <input type="checkbox"/> 10	1.6	BEA 16/116	on rail (1)
0.55	1.45	MS116-1.60 1SAM 250 000 R1006	1.00 - 1.60	19.2	A9-30-10 <input type="checkbox"/> <input type="checkbox"/> <input type="checkbox"/> <input type="checkbox"/> 1SBL 141 001 R <input type="checkbox"/> <input type="checkbox"/> 10	1.6	BEA 16/116	on rail (1)
0.75	1.9	MS116-2.50 1SAM 250 000 R1007	1.60 - 2.50	30	A9-30-10 <input type="checkbox"/> <input type="checkbox"/> <input type="checkbox"/> <input type="checkbox"/> 1SBL 141 001 R <input type="checkbox"/> <input type="checkbox"/> 10	2.5	BEA 16/116	on rail (1)
1.1	2.59	MS116-4.00 1SAM 250 000 R1008	2.50 - 4.00	48	A9-30-10 <input type="checkbox"/> <input type="checkbox"/> <input type="checkbox"/> <input type="checkbox"/> 1SBL 141 001 R <input type="checkbox"/> <input type="checkbox"/> 10	4	BEA 16/116	on rail (1)
1.5	3.45	MS116-4.00 1SAM 250 000 R1008	2.50 - 4.00	48	A9-30-10 <input type="checkbox"/> <input type="checkbox"/> <input type="checkbox"/> <input type="checkbox"/> 1SBL 141 001 R <input type="checkbox"/> <input type="checkbox"/> 10	4	BEA 16/116	on rail (1)
2.2	4.8	MS116-6.30 1SAM 250 000 R1009	4.00 - 6.30	75.6	A9-30-10 <input type="checkbox"/> <input type="checkbox"/> <input type="checkbox"/> <input type="checkbox"/> 1SBL 141 001 R <input type="checkbox"/> <input type="checkbox"/> 10	6.3	BEA 16/116	on rail (1)
3	6.6	MS325-9.00 1SAM 150 000 R1010	6.30 - 9.00	135	A9-30-10 <input type="checkbox"/> <input type="checkbox"/> <input type="checkbox"/> <input type="checkbox"/> 1SBL 141 001 R <input type="checkbox"/> <input type="checkbox"/> 10	9	BEA 16/325	on rail (1)
4	8.5	MS325-9.00 1SAM 150 000 R1010	6.30 - 9.00	135	A9-30-10 <input type="checkbox"/> <input type="checkbox"/> <input type="checkbox"/> <input type="checkbox"/> 1SBL 141 001 R <input type="checkbox"/> <input type="checkbox"/> 10	9	BEA 16/325	on rail (1)
5.5	11.5	MS325-12.5 1SAM 150 000 R1011	9.00 - 12.5	187.5	A12-30-10 <input type="checkbox"/> <input type="checkbox"/> <input type="checkbox"/> <input type="checkbox"/> 1SBL 161 001 R <input type="checkbox"/> <input type="checkbox"/> 10	12	BEA 16/325	on rail (1)
7.5	15.5	MS325-16.0 1SAM 150 000 R1012	12.5 - 16.0	240	A16-30-10 <input type="checkbox"/> <input type="checkbox"/> <input type="checkbox"/> <input type="checkbox"/> 1SBL 181 001 R <input type="checkbox"/> <input type="checkbox"/> 10	16	BEA 16/325	on rail (1)
9	18.3	MS325-20.0 1SAM 150 000 R1013	16.0 - 20.0	300	A26-30-10 <input type="checkbox"/> <input type="checkbox"/> <input type="checkbox"/> <input type="checkbox"/> 1SBL 241 001 R <input type="checkbox"/> <input type="checkbox"/> 10	20	BEA 26/325	PM 26-13
11	22	MS325-25.0 1SAM 150 000 R1014	20.0 - 25.0	375	A26-30-10 <input type="checkbox"/> <input type="checkbox"/> <input type="checkbox"/> <input type="checkbox"/> 1SBL 241 001 R <input type="checkbox"/> <input type="checkbox"/> 10	25	BEA 26/325	PM 26-13
15	30	MS450-32.0 1SAM 450 000 R1004	22.0 - 32.0	384	A30-30-10 <input type="checkbox"/> <input type="checkbox"/> <input type="checkbox"/> <input type="checkbox"/> 1SBL 281 001 R <input type="checkbox"/> <input type="checkbox"/> 10	30	BEA 40/450	-
18.5	37	MS450-40.0 1SAM 450 000 R1005	28.0 - 40.0	480	A40-30-10 <input type="checkbox"/> <input type="checkbox"/> <input type="checkbox"/> <input type="checkbox"/> 1SBL 321 001 R <input type="checkbox"/> <input type="checkbox"/> 10	38	BEA 40/450	-
22	44	MS450-50.0 1SAM 450 000 R1007	40.0 - 50.0	600	A50-30-00 <input type="checkbox"/> <input type="checkbox"/> <input type="checkbox"/> <input type="checkbox"/> 1SBL 351 001 R <input type="checkbox"/> <input type="checkbox"/> 00	47.5	BEA 50/450	-
30	60	MS495-63.0 1SAM 550 000 R1007	45.0 - 63.0	756	A63-30-00 <input type="checkbox"/> <input type="checkbox"/> <input type="checkbox"/> <input type="checkbox"/> 1SBL 371 001 R <input type="checkbox"/> <input type="checkbox"/> 00	60	BEA 75/495	-
37	72	MS495-75.0 1SAM 550 000 R1008	57.0 - 75.0	900	A75-30-00 <input type="checkbox"/> <input type="checkbox"/> <input type="checkbox"/> <input type="checkbox"/> 1SBL 411 001 R <input type="checkbox"/> <input type="checkbox"/> 00	72.5	BEA 75/495	-
45	85	MS495-90.0 1SAM 550 000 R1009	70.0 - 90.0	1080	A95-30-00 <input type="checkbox"/> <input type="checkbox"/> <input type="checkbox"/> <input type="checkbox"/> 1SFL 431 001 R <input type="checkbox"/> <input type="checkbox"/> 00	85	BEA 110/495	-
51	94	MS495-100 1SAM 550 000 R1010	80.0 - 100	1200	A95-30-00 <input type="checkbox"/> <input type="checkbox"/> <input type="checkbox"/> <input type="checkbox"/> 1SFL 431 001 R <input type="checkbox"/> <input type="checkbox"/> 00	96	BEA 110/495	-

(1) No mounting plate required. MS.. can be fitted directly on a 35 mm rail.

>> Coil Voltage Codes	pages 0/1, 0/2 in the Cover Flap
>> Accessories, Ordering Details.....	page 57
>> Other Manual Motor Starters and Contactors.....	Main Catalogue



Direct-On-Line Starters Protected by Manual Motor Starter

Coordination Type 2

Ordering Details - Coordination type 2, 400 V, 16 kA, 50/60 Hz

IEC		Manual Motor Starter			Contactor		Accessories	
AC-3, 400 V Rated power kW	Rated current A	Type	Current setting range A	Magnetic tripping current A	Type	Allowed Setting current A	Type	Fixing
		Order Code			state coil voltage <input type="checkbox"/> <input type="checkbox"/>			
		Unit piece			state coil voltage code <input type="checkbox"/> <input type="checkbox"/>			
					Unit piece			
0.06	0.22	MS116-0.25 1SAM 250 000 R1002	0.16 - 0.25	3	A9-30-10 <input type="checkbox"/> <input type="checkbox"/> 1SBL 141 001 R <input type="checkbox"/> <input type="checkbox"/> 10	0.25	BEA 16/116	on rail (1)
0.09	0.34	MS116-0.40 1SAM 250 000 R1003	0.25 - 0.40	4.8	A9-30-10 <input type="checkbox"/> <input type="checkbox"/> 1SBL 141 001 R <input type="checkbox"/> <input type="checkbox"/> 10	0.4	BEA 16/116	on rail (1)
0.12	0.44	MS116-0.63 1SAM 250 000 R1004	0.40 - 0.63	7.56	A9-30-10 <input type="checkbox"/> <input type="checkbox"/> 1SBL 141 001 R <input type="checkbox"/> <input type="checkbox"/> 10	0.63	BEA 16/116	on rail (1)
0.18	0.72	MS116-1.00 1SAM 250 000 R1005	0.63 - 1.00	12	A9-30-10 <input type="checkbox"/> <input type="checkbox"/> 1SBL 141 001 R <input type="checkbox"/> <input type="checkbox"/> 10	1	BEA 16/116	on rail (1)
0.25	0.83	MS116-1.00 1SAM 250 000 R1005	0.63 - 1.00	12	A9-30-10 <input type="checkbox"/> <input type="checkbox"/> 1SBL 141 001 R <input type="checkbox"/> <input type="checkbox"/> 10	1	BEA 16/116	on rail (1)
0.37	1.12	MS116-1.60 1SAM 250 000 R1006	1.00 - 1.60	19.2	A9-30-10 <input type="checkbox"/> <input type="checkbox"/> 1SBL 141 001 R <input type="checkbox"/> <input type="checkbox"/> 10	1.6	BEA 16/116	on rail (1)
0.55	1.45	MS116-1.60 1SAM 250 000 R1006	1.00 - 1.60	19.2	A9-30-10 <input type="checkbox"/> <input type="checkbox"/> 1SBL 141 001 R <input type="checkbox"/> <input type="checkbox"/> 10	1.6	BEA 16/116	on rail (1)
0.75	1.9	MS116-2.50 1SAM 250 000 R1007	1.60 - 2.50	30	A9-30-10 <input type="checkbox"/> <input type="checkbox"/> 1SBL 141 001 R <input type="checkbox"/> <input type="checkbox"/> 10	2.5	BEA 16/116	on rail (1)
1.1	2.59	MS116-4.00 1SAM 250 000 R1008	2.50 - 4.00	48	A16-30-10 <input type="checkbox"/> <input type="checkbox"/> 1SBL 181 001 R <input type="checkbox"/> <input type="checkbox"/> 10	4	BEA 16/116	on rail (1)
1.5	3.45	MS116-4.00 1SAM 250 000 R1008	2.50 - 4.00	48	A16-30-10 <input type="checkbox"/> <input type="checkbox"/> 1SBL 181 001 R <input type="checkbox"/> <input type="checkbox"/> 10	4	BEA 16/116	on rail (1)
2.2	4.8	MS116-6.30 1SAM 250 000 R1009	4.00 - 6.30	75.6	A16-30-10 <input type="checkbox"/> <input type="checkbox"/> 1SBL 181 001 R <input type="checkbox"/> <input type="checkbox"/> 10	6.3	BEA 16/116	on rail (1)
3	6.48	MS116-10.0 1SAM 250 000 R1010	6.30 - 10.0	120	A26-30-10 <input type="checkbox"/> <input type="checkbox"/> 1SBL 241 001 R <input type="checkbox"/> <input type="checkbox"/> 10	10	BEA 26/116	PM 26-13
4	8.6	MS116-10.0 1SAM 250 000 R1010	6.30 - 10.0	120	A26-30-10 <input type="checkbox"/> <input type="checkbox"/> 1SBL 241 001 R <input type="checkbox"/> <input type="checkbox"/> 10	10	BEA 26/116	PM 26-13
5.5	11.1	MS116-12.0 1SAM 250 000 R1012	8.00 - 12.0	144	A26-30-10 <input type="checkbox"/> <input type="checkbox"/> 1SBL 241 001 R <input type="checkbox"/> <input type="checkbox"/> 10	12	BEA 26/116	PM 26-13
7.5	14.8	MS116-16.0 1SAM 250 000 R1011	10.0 - 16.0	192	A26-30-10 <input type="checkbox"/> <input type="checkbox"/> 1SBL 241 001 R <input type="checkbox"/> <input type="checkbox"/> 10	16	BEA 26/116	PM 26-13

(1) No mounting plate required. MS.. can be fitted directly on a 35 mm rail.

Ordering Details - Main Accessories

Description	Type	Order Code	Pack ^{ing} pieces	Weight kg
Connecting links	BEA 16/116	1SBN 081 406 R1000	10	0.020
	BEA 26/116	1SBN 082 406 R1000	10	0.024
	BEA 26/325	1SBN 082 406 R1001	10	0.031
	BEA 40/450	1SBN 083 206 R1000	1	0.061
	BEA 50/450	1SBN 083 506 R1000	1	0.062
	BEA 75/495	1SBN 084 106 R1000	1	0.120
	BEA 110/495	1SBN 084 506 R1000	1	0.124
Mounting plate	PM 26-13	1SBN 092 406 R1000	2	0.160

>> Coil Voltage Codespages 0/1, 0/2 in the Cover Flap
 >> Accessories, Ordering Details..... page 57
 >> Other Manual Motor Starters and Contactors..... Main Catalogue



Direct-On-Line Starters Protected by Manual Motor Starter

Coordination Type 2

Ordering Details - Coordination type 2, 400 V, 50 kA, 50/60 Hz

IEC		Manual Motor Starter			Contactor		Accessories	
Rated power kW	Rated current A	Type	Current setting range A	Magnetic tripping current A	Type	Allowed Setting current A	Type	Fixing
		Order Code			state coil voltage <input type="checkbox"/> <input type="checkbox"/> <input type="checkbox"/> <input type="checkbox"/>			
		Unit piece			state coil voltage code <input type="checkbox"/> <input type="checkbox"/>			
0.06	0.22	MS116-0.25 1SAM 250 000 R1002	0.16 - 0.25	3	A9-30-10 <input type="checkbox"/> <input type="checkbox"/> <input type="checkbox"/> <input type="checkbox"/> 1SBL 141 001 R <input type="checkbox"/> <input type="checkbox"/> 10	0.25	BEA 16/116	on rail (1)
0.09	0.34	MS116-0.40 1SAM 250 000 R1003	0.25 - 0.40	4.8	A9-30-10 <input type="checkbox"/> <input type="checkbox"/> <input type="checkbox"/> <input type="checkbox"/> 1SBL 141 001 R <input type="checkbox"/> <input type="checkbox"/> 10	0.4	BEA 16/116	on rail (1)
0.12	0.44	MS116-0.63 1SAM 250 000 R1004	0.40 - 0.63	7.56	A9-30-10 <input type="checkbox"/> <input type="checkbox"/> <input type="checkbox"/> <input type="checkbox"/> 1SBL 141 001 R <input type="checkbox"/> <input type="checkbox"/> 10	0.63	BEA 16/116	on rail (1)
0.18	0.72	MS116-1.00 1SAM 250 000 R1005	0.63 - 1.00	12	A9-30-10 <input type="checkbox"/> <input type="checkbox"/> <input type="checkbox"/> <input type="checkbox"/> 1SBL 141 001 R <input type="checkbox"/> <input type="checkbox"/> 10	1	BEA 16/116	on rail (1)
0.25	0.83	MS116-1.00 1SAM 250 000 R1005	0.63 - 1.00	12	A9-30-10 <input type="checkbox"/> <input type="checkbox"/> <input type="checkbox"/> <input type="checkbox"/> 1SBL 141 001 R <input type="checkbox"/> <input type="checkbox"/> 10	1	BEA 16/116	on rail (1)
0.37	1.12	MS116-1.60 1SAM 250 000 R1006	1.00 - 1.60	19.2	A9-30-10 <input type="checkbox"/> <input type="checkbox"/> <input type="checkbox"/> <input type="checkbox"/> 1SBL 141 001 R <input type="checkbox"/> <input type="checkbox"/> 10	1.6	BEA 16/116	on rail (1)
0.55	1.45	MS116-1.60 1SAM 250 000 R1006	1.00 - 1.60	19.2	A9-30-10 <input type="checkbox"/> <input type="checkbox"/> <input type="checkbox"/> <input type="checkbox"/> 1SBL 141 001 R <input type="checkbox"/> <input type="checkbox"/> 10	1.6	BEA 16/116	on rail (1)
0.75	1.9	MS116-2.50 1SAM 250 000 R1007	1.60 - 2.50	30	A9-30-10 <input type="checkbox"/> <input type="checkbox"/> <input type="checkbox"/> <input type="checkbox"/> 1SBL 141 001 R <input type="checkbox"/> <input type="checkbox"/> 10	2.5	BEA 16/116	on rail (1)
1.1	2.59	MS116-4.00 1SAM 250 000 R1008	2.50 - 4.00	48	A16-30-10 <input type="checkbox"/> <input type="checkbox"/> <input type="checkbox"/> <input type="checkbox"/> 1SBL 181 001 R <input type="checkbox"/> <input type="checkbox"/> 10	4	BEA 16/116	on rail (1)
1.5	3.45	MS116-4.00 1SAM 250 000 R1008	2.50 - 4.00	48	A16-30-10 <input type="checkbox"/> <input type="checkbox"/> <input type="checkbox"/> <input type="checkbox"/> 1SBL 181 001 R <input type="checkbox"/> <input type="checkbox"/> 10	4	BEA 16/116	on rail (1)
2.2	4.8	MS116-6.30 1SAM 250 000 R1009	4.00 - 6.30	75.6	A16-30-10 <input type="checkbox"/> <input type="checkbox"/> <input type="checkbox"/> <input type="checkbox"/> 1SBL 181 001 R <input type="checkbox"/> <input type="checkbox"/> 10	6.3	BEA 16/116	on rail (1)
3	6.6	MS325-9.00 1SAM 150 000 R1010	6.30 - 9.00	135	A26-30-10 <input type="checkbox"/> <input type="checkbox"/> <input type="checkbox"/> <input type="checkbox"/> 1SBL 241 001 R <input type="checkbox"/> <input type="checkbox"/> 10	9	BEA 26/325	PM-26-13
4	8.5	MS325-9.00 1SAM 150 000 R1010	6.30 - 9.00	135	A26-30-10 <input type="checkbox"/> <input type="checkbox"/> <input type="checkbox"/> <input type="checkbox"/> 1SBL 241 001 R <input type="checkbox"/> <input type="checkbox"/> 10	9	BEA 26/325	PM 26-13
5.5	11.5	MS325-12.5 1SAM 150 000 R1011	9.00 - 12.5	187.5	A26-30-10 <input type="checkbox"/> <input type="checkbox"/> <input type="checkbox"/> <input type="checkbox"/> 1SBL 241 001 R <input type="checkbox"/> <input type="checkbox"/> 10	12.5	BEA 26/325	PM 26-13
7.5	15.5	MS325-16.0 1SAM 150 000 R1012	12.5 - 16.0	240	A26-30-10 <input type="checkbox"/> <input type="checkbox"/> <input type="checkbox"/> <input type="checkbox"/> 1SBL 241 001 R <input type="checkbox"/> <input type="checkbox"/> 10	16	BEA 26/325	PM 26-13
9	18.3	MS325-20.0 1SAM 150 000 R1013	16.0 - 20.0	300	A26-30-10 <input type="checkbox"/> <input type="checkbox"/> <input type="checkbox"/> <input type="checkbox"/> 1SBL 241 001 R <input type="checkbox"/> <input type="checkbox"/> 10	20	BEA 26/325	PM 26-13
11	22	MS325-25.0 1SAM 150 000 R1014	20.0 - 25.0	375	A30-30-10 <input type="checkbox"/> <input type="checkbox"/> <input type="checkbox"/> <input type="checkbox"/> 1SBL 281 001 R <input type="checkbox"/> <input type="checkbox"/> 10	25	BEA 26/325	PM 26-13
15	30	MS450-32.0 1SAM 450 000 R1004	22.0 - 32.0	384	A40-30-10 <input type="checkbox"/> <input type="checkbox"/> <input type="checkbox"/> <input type="checkbox"/> 1SBL 321 001 R <input type="checkbox"/> <input type="checkbox"/> 10	30	BEA 40/450	-
18.5	37	MS450-40.0 1SAM 450 000 R1005	28.0 - 40.0	480	A40-30-10 <input type="checkbox"/> <input type="checkbox"/> <input type="checkbox"/> <input type="checkbox"/> 1SBL 321 001 R <input type="checkbox"/> <input type="checkbox"/> 10	38	BEA 40/450	-
22	44	MS450-50.0 1SAM 450 000 R1007	40.0 - 50.0	600	A63-30-00 <input type="checkbox"/> <input type="checkbox"/> <input type="checkbox"/> <input type="checkbox"/> 1SBL 371 001 R <input type="checkbox"/> <input type="checkbox"/> 00	47.5	BEA 50/450	-
30	60	MS495-63.0 1SAM 550 000 R1007	45.0 - 63.0	756	A75-30-00 <input type="checkbox"/> <input type="checkbox"/> <input type="checkbox"/> <input type="checkbox"/> 1SBL 411 001 R <input type="checkbox"/> <input type="checkbox"/> 00	60	BEA 75/495	-
37	72	MS495-75.0 1SAM 550 000 R1008	57.0 - 75.0	900	A75-30-00 <input type="checkbox"/> <input type="checkbox"/> <input type="checkbox"/> <input type="checkbox"/> 1SBL 411 001 R <input type="checkbox"/> <input type="checkbox"/> 00	72.5	BEA 75/495	-
45	85	MS495-90.0 1SAM 550 000 R1009	70.0 - 90.0	1080	A95-30-00 <input type="checkbox"/> <input type="checkbox"/> <input type="checkbox"/> <input type="checkbox"/> 1SFL 431 001 R <input type="checkbox"/> <input type="checkbox"/> 00	85	BEA 110/495	-
51	94	MS495-100 1SAM 550 000 R1010	80.0 - 100	1200	A95-30-00 <input type="checkbox"/> <input type="checkbox"/> <input type="checkbox"/> <input type="checkbox"/> 1SFL 431 001 R <input type="checkbox"/> <input type="checkbox"/> 00	96	BEA 110/495	-

(1) No mounting plate required. MS.. can be fitted directly on a 35 mm rail.

>> Coil Voltage Codes	pages 0/1, 0/2 in the Cover Flap
>> Accessories, Ordering Details.....	page 57
>> Other Manual Motor Starters and Contactors.....	Main Catalogue



Reversing Starters Open Type Version, in Kit Form

Protected by Manual Motor Starter

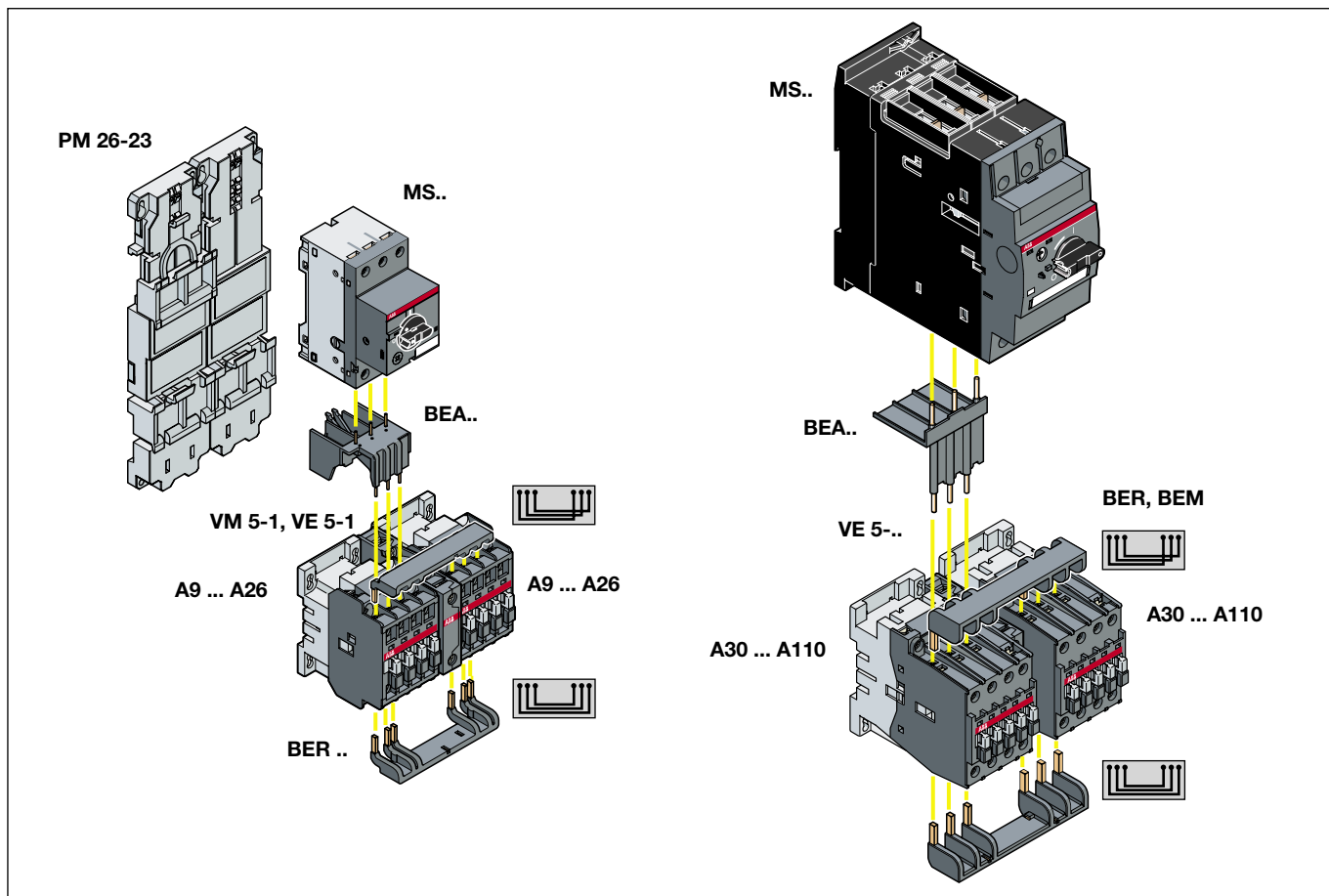

Selection Table

Manual motor starters	MS 116				MS 325				MS 450			MS 495																	
3-pole a.c. operated contactors	A9	A12	A16	A26	A9	A12	A16	A26	A30	A40	A50	A63	A75	A95	A110														
Connecting links	BEA 16/116				BEA 26/116				BEA 16/325			BEA 26/325				BEA 40/450			BEA 50/450			BEA 75/495				BEA 110/495			
Connection sets	BER 16V ⁽¹⁾				BER 40V ⁽¹⁾				BER 16V ⁽¹⁾			BER 40V ⁽¹⁾				BEM 75-30				BEM 110-30									
Mounting plate	PM 26-23																												
Mechanical /electrical interlock units	VM 5-1 / VE 5-1										VE 5-2																		

(1) If only an electrical interlocking is required between contactors A 9 up to A 40, use **BER 16** and **BER 40** connection sets for contactors with N.C. built-in auxiliary contacts to reduce the space between contactors.

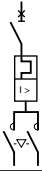

Reversing Starters Open Type Version, in Kit Form

Protected by Manual Motor Starter

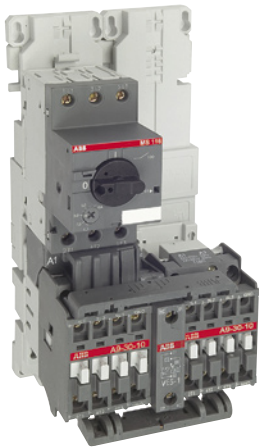

1SBC5 9292 EFC002

MS 116
+ 2 x A 9-30-10
+ BEA 16/116
+ VE 5-1
+ BER 16V
+ PM 26-23

Application

Reversing starters for controlling three-phase asynchronous motors:

- up to an operational voltage of 415 V - 50 or 60 Hz
- for a starting time of 1.5 s max.
 - and a switching frequency of ≤ 15 starts an hour with a load factor of 80 %
 - of ≤ 30 starts an hour with a load factor of 50 %
- with an ambient temperature near the devices $< 50\text{ }^{\circ}\text{C}$
- type 1 or type 2 coordination, complying with IEC 60947-4-1 / EN 60947-4-1

Coordination

In the event of a short-circuit, the starter is subjected to thermal stresses, in addition to very high electrodynamic stresses, proportional to short-current time.

The capacity to withstand these high stresses depends upon the perfect coordination of the devices which make up the starter.

Standard EN 60947-4-1/IEC 60947-4-1 defines the two types of coordination according to the anticipated level of service continuity.

The tables overleaf show, for each of the two coordination types, the most usual combination between the MS... manual motor starters and the contactors, according to AC-3 currents and motor powers for:

- coordination type 1 and type 2 at 400 V, 50 / 60 Hz, $I_q = 16\text{ kA}$
- coordination type 1 and type 2 at 400 V, 50 / 60 Hz, $I_q = 50\text{ kA}$.

Mounting and Connection Accessory Description

The BEA connecting links, the VE 5-... or VM 5-1 interlock unit, the BER or BEM connection sets and the PM 26-23 mounting plate allow to realize reversing starters, including A... serie contactors and MS... manual motor starter controlling and protecting motors against overloads and short-circuits according to coordination types 1 and 2.

These accessories eliminate the potential risk of wiring errors, reduce the time required to install, to test and to maintain a reversing starter.

The BEA insulated 3-pole connecting link (touch safe) is used to electrically and mechanically connect the MS.. manual motor starter and the A... serie contactor.

The BER / BEM connection set is used to do a safe and simple connection between both contactor main terminals.

The interlocking function can be easily assured by a simple mounting of :

- a VE 5-.. unit between both contactors for a mechanical and electrical interlocking
- a VM 5-1 unit between both contactors for a mechanical interlocking and add-on N.C. auxiliary contacts for the electrical interlocking (or use contactors with built-in N.C. auxiliary contacts).

Note: if only an electrical interlocking is required between contactors A 9 up to A 40, use BER 16 and BER 40 connection sets and contactors with built-in N.C. auxiliary contacts (A 9-30-01 ... A 40-30-01 contactors, see main catalogue).

The PM 26-23 mounting plate facilitates:

- the mounting and dismounting of the contactors and the manual motor starter
- the simple snap fitting of the reversing starter onto standard 35 mm rails within the control panel, or screw fitting onto the mounting plate.



Reversing Starters Protected by Manual Motor Starter

Coordination Type 1

Ordering Details - Coordination type 1, 400 V, 16 kA, 50/60 Hz

IEC		Manual Motor Starter			Contactor		Accessories			
Rated power kW	Rated current A	Type	Current setting range A	Magnetic tripping current A	Type	Allowed Setting current A	Connecting link between MS. and contactors	Interlock unit	Connection set for the contactors	Mounting plate
		Order Code			state coil voltage					
		Unit piece			Order Code					
0.06	0.22	MS116-0.25 1SAM 250 000 R1002	0.16 - 0.25	3	2 x A9-30-10 1SBL 141 001 R□□10	0.25	BEA 16/116	VE 5-1	BER 16V	PM 26-23
0.09	0.34	MS116-0.40 1SAM 250 000 R1003	0.25 - 0.40	4.8	2 x A9-30-10 1SBL 141 001 R□□10	0.4	BEA 16/116	VE 5-1	BER 16V	PM 26-23
0.12	0.44	MS116-0.63 1SAM 250 000 R1004	0.40 - 0.63	7.56	2 x A9-30-10 1SBL 141 001 R□□10	0.63	BEA 16/116	VE 5-1	BER 16V	PM 26-23
0.18	0.72	MS116-1.00 1SAM 250 000 R1005	0.63 - 1.00	12	2 x A9-30-10 1SBL 141 001 R□□10	1	BEA 16/116	VE 5-1	BER 16V	PM 26-23
0.25	0.83	MS116-1.00 1SAM 250 000 R1005	0.63 - 1.00	12	2 x A9-30-10 1SBL 141 001 R□□10	1	BEA 16/116	VE 5-1	BER 16V	PM 26-23
0.37	1.12	MS116-1.60 1SAM 250 000 R1006	1.00 - 1.60	19.2	2 x A9-30-10 1SBL 141 001 R□□10	1.6	BEA 16/116	VE 5-1	BER 16V	PM 26-23
0.55	1.45	MS116-1.60 1SAM 250 000 R1006	1.00 - 1.60	19.2	2 x A9-30-10 1SBL 141 001 R□□10	1.6	BEA 16/116	VE 5-1	BER 16V	PM 26-23
0.75	1.9	MS116-2.50 1SAM 250 000 R1007	1.60 - 2.50	30	2 x A9-30-10 1SBL 141 001 R□□10	2.5	BEA 16/116	VE 5-1	BER 16V	PM 26-23
1.1	2.59	MS116-4.00 1SAM 250 000 R1008	2.50 - 4.00	48	2 x A9-30-10 1SBL 141 001 R□□10	4	BEA 16/116	VE 5-1	BER 16V	PM 26-23
1.5	3.45	MS116-4.00 1SAM 250 000 R1008	2.50 - 4.00	48	2 x A9-30-10 1SBL 141 001 R□□10	4	BEA 16/116	VE 5-1	BER 16V	PM 26-23
2.2	4.8	MS116-6.30 1SAM 250 000 R1009	4.00 - 6.30	75.6	2 x A9-30-10 1SBL 141 001 R□□10	6.3	BEA 16/116	VE 5-1	BER 16V	PM 26-23
3	6.48	MS116-10.0 1SAM 250 000 R1010	6.30 - 10.0	120	2 x A12-30-10 1SBL 161 001 R□□10	10	BEA 16/116	VE 5-1	BER 16V	PM 26-23
4	8.6	MS116-10.0 1SAM 250 000 R1010	6.30 - 10.0	120	2 x A12-30-10 1SBL 161 001 R□□10	10	BEA 16/116	VE 5-1	BER 16V	PM 26-23
5.5	11.1	MS116-12.0 1SAM 250 000 R1012	8.00 - 12.0	144	2 x A12-30-10 1SBL 161 001 R□□10	12	BEA 16/116	VE 5-1	BER 16V	PM 26-23
7.5	14.8	MS116-16.0 1SAM 250 000 R1011	10.0 - 16.0	192	2 x A16-30-10 1SBL 181 001 R□□10	16	BEA 16/116	VE 5-1	BER 16V	PM 26-23

Ordering Details - Main Accessories

Description	Type	Order Code	Pack ^{ing} pieces	Weight kg
Connecting links	BEA 16/116	1SBN 081 406 R1000	10	0.020
	BEA 16/325	1SBN 081 406 R1001	10	0.031
	BEA 26/325	1SBN 082 406 R1001	10	0.031
	BEA 40/450	1SBN 083 206 R1000	1	0.061
	BEA 50/450	1SBN 083 506 R1000	1	0.062
	BEA 75/495	1SBN 084 106 R1000	1	0.120
	BEA 110/495	1SBN 084 506 R1000	1	0.124
Mechanical interlock unit	VM 5-1	1SBN 030 100 R1000	1	0.066
Mechanical & electrical interlock units	VE 5-1	1SBN 030 110 R1000	1	0.076
	VE 5-2	1SBN 030 210 R1000	1	0.146
Connection sets	BER 16V	1SBN 081 411 R1000	1	0.045
	BER 40V	1SBN 082 411 R1000	1	0.085
	BEM 75-30	1SBN 083 501 R1000	1	0.243
	BEM 110-30	1SFN 084 301 R1000	1	0.450
Mounting plate	PM 26-23	1SBN 091 407 R1000	1	0.330

>> Coil Voltage Codespages 0/1, 0/2 in the Cover Flap
 >> Accessories, Ordering Details page 57
 >> Other Manual Motor Starters and Contactors Main Catalogue



Reversing Starters Protected by Manual Motor Starter

Coordination Type 1

Ordering Details - Coordination type 1, 400 V, 50 kA, 50/60 Hz

IEC		Manual Motor Starter			Contactor		Accessories			
AC-3, 400 V Rated power kW	Rated current A	Type	Current setting range A	Magnetic tripping current A	Type	Allowed Setting current A	Connecting link between MS.. and contactors	Interlock unit	Connection set for the contactors	Mounting plate
		Order Code			Order Code					
		Unit piece			state coil voltage [] [] [] [] state coil voltage code [] [] [] [] Unit piece					
0.06	0.22	MS116-0.25 1SAM 250 000 R1002	0.16 - 0.25	3	2 x A9-30-10 [] [] [] [] 1SBL 141 001 R [] [] 10	0.25	BEA 16/116	VE 5-1	BER 16V	PM 26-23
0.09	0.34	MS116-0.40 1SAM 250 000 R1003	0.25 - 0.40	4.8	2 x A9-30-10 [] [] [] [] 1SBL 141 001 R [] [] 10	0.4	BEA 16/116	VE 5-1	BER 16V	PM 26-23
0.12	0.44	MS116-0.63 1SAM 250 000 R1004	0.40 - 0.63	7.56	2 x A9-30-10 [] [] [] [] 1SBL 141 001 R [] [] 10	0.63	BEA 16/116	VE 5-1	BER 16V	PM 26-23
0.18	0.72	MS116-1.00 1SAM 250 000 R1005	0.63 - 1.00	12	2 x A9-30-10 [] [] [] [] 1SBL 141 001 R [] [] 10	1	BEA 16/116	VE 5-1	BER 16V	PM 26-23
0.25	0.83	MS116-1.00 1SAM 250 000 R1005	0.63 - 1.00	12	2 x A9-30-10 [] [] [] [] 1SBL 141 001 R [] [] 10	1	BEA 16/116	VE 5-1	BER 16V	PM 26-23
0.37	1.12	MS116-1.60 1SAM 250 000 R1006	1.00 - 1.60	19.2	2 x A9-30-10 [] [] [] [] 1SBL 141 001 R [] [] 10	1.6	BEA 16/116	VE 5-1	BER 16V	PM 26-23
0.55	1.45	MS116-1.60 1SAM 250 000 R1006	1.00 - 1.60	19.2	2 x A9-30-10 [] [] [] [] 1SBL 141 001 R [] [] 10	1.6	BEA 16/116	VE 5-1	BER 16V	PM 26-23
0.75	1.9	MS116-2.50 1SAM 250 000 R1007	1.60 - 2.50	30	2 x A9-30-10 [] [] [] [] 1SBL 141 001 R [] [] 10	2.5	BEA 16/116	VE 5-1	BER 16V	PM 26-23
1.1	2.59	MS116-4.00 1SAM 250 000 R1008	2.50 - 4.00	48	2 x A9-30-10 [] [] [] [] 1SBL 141 001 R [] [] 10	4	BEA 16/116	VE 5-1	BER 16V	PM 26-23
1.5	3.45	MS116-4.00 1SAM 250 000 R1008	2.50 - 4.00	48	2 x A9-30-10 [] [] [] [] 1SBL 141 001 R [] [] 10	4	BEA 16/116	VE 5-1	BER 16V	PM 26-23
2.2	4.8	MS116-6.30 1SAM 250 000 R1009	4.00 - 6.30	75.6	2 x A9-30-10 [] [] [] [] 1SBL 141 001 R [] [] 10	6.3	BEA 16/116	VE 5-1	BER 16V	PM 26-23
3	6.6	MS325-9.00 1SAM 150 000 R1010	6.30 - 9.00	135	2 x A9-30-10 [] [] [] [] 1SBL 141 001 R [] [] 10	9	BEA 16/325	VE 5-1	BER 16V	PM 26-23
4	8.5	MS325-9.00 1SAM 150 000 R1010	6.30 - 9.00	135	2 x A9-30-10 [] [] [] [] 1SBL 141 001 R [] [] 10	9	BEA 16/325	VE 5-1	BER 16V	PM 26-23
5.5	11.5	MS325-12.5 1SAM 150 000 R1011	9.00 - 12.5	187.5	2 x A12-30-10 [] [] [] [] 1SBL 161 001 R [] [] 10	12	BEA 16/325	VE 5-1	BER 16V	PM 26-23
7.5	15.5	MS325-16.0 1SAM 150 000 R1012	12.5 - 16.0	240	2 x A16-30-10 [] [] [] [] 1SBL 181 001 R [] [] 10	16	BEA 16/325	VE 5-1	BER 16V	PM 26-23
9	18.3	MS325-20.0 1SAM 150 000 R1013	16.0 - 20.0	300	2 x A26-30-10 [] [] [] [] 1SBL 241 001 R [] [] 10	20	BEA 26/325	VE 5-1	BER 40V	PM 26-23
11	22	MS325-25.0 1SAM 150 000 R1014	20.0 - 25.0	375	2 x A26-30-10 [] [] [] [] 1SBL 241 001 R [] [] 10	25	BEA 26/325	VE 5-1	BER 40V	PM 26-23
15	30	MS450-32.0 1SAM 450 000 R1004	22.0 - 32.0	384	2 x A30-30-10 [] [] [] [] 1SBL 281 001 R [] [] 10	30	BEA 40/450	VE 5-1	BER 40V	-
18.5	37	MS450-40.0 1SAM 450 000 R1005	28.0 - 40.0	480	2 x A40-30-10 [] [] [] [] 1SBL 321 001 R [] [] 10	38	BEA 40/450	VE 5-1	BER 40V	-
22	44	MS450-50.0 1SAM 450 000 R1007	40.0 - 50.0	600	2 x A50-30-00 [] [] [] [] 1SBL 351 001 R [] [] 00	47.5	BEA 50/450	VE 5-2	BEM 75-30	-
30	60	MS495-63.0 1SAM 550 000 R1007	45.0 - 63.0	756	2 x A63-30-00 [] [] [] [] 1SBL 371 001 R [] [] 00	60	BEA 75/495	VE 5-2	BEM 75-30	-
37	72	MS495-75.0 1SAM 550 000 R1008	57.0 - 75.0	900	2 x A75-30-00 [] [] [] [] 1SBL 411 001 R [] [] 00	72.5	BEA 75/495	VE 5-2	BEM 75-30	-
45	85	MS495-90.0 1SAM 550 000 R1009	70.0 - 90.0	1080	2 x A95-30-00 [] [] [] [] 1SFL 431 001 R [] [] 00	85	BEA 110/495	VE 5-2	BEM 110-30	-
51	94	MS495-100 1SAM 550 000 R1010	80.0 - 100	1200	2 x A95-30-00 [] [] [] [] 1SFL 431 001 R [] [] 00	96	BEA 110/495	VE 5-2	BEM 110-30	-

>> Coil Voltage Codes pages 0/1, 0/2 in the Cover Flap
 >> Accessories, Ordering Details page 57
 >> Other Manual Motor Starters and Contactors Main Catalogue



Reversing Starters Protected by Manual Motor Starter

Coordination Type 2

Ordering Details - Coordination type 2, 400 V, 16 kA, 50/60 Hz

IEC		Manual Motor Starter			Contactor		Accessories			
Rated power kW	Rated current A	Type	Current setting range A	Magnetic tripping current A	Type	Allowed Setting current A	Connecting link between MS. and contactors	Interlock unit	Connection set for the contactors	Mounting plate
		Order Code			state coil voltage					
		Unit piece			Unit piece					
0.06	0.22	MS116-0.25 1SAM 250 000 R1002	0.16 - 0.25	3	2 x A9-30-10 1SBL 141 001 R□□10	0.25	BEA 16/116	VE 5-1	BER 16V	PM 26-23
0.09	0.34	MS116-0.40 1SAM 250 000 R1003	0.25 - 0.40	4.8	2 x A9-30-10 1SBL 141 001 R□□10	0.4	BEA 16/116	VE 5-1	BER 16V	PM 26-23
0.12	0.44	MS116-0.63 1SAM 250 000 R1004	0.40 - 0.63	7.56	2 x A9-30-10 1SBL 141 001 R□□10	0.63	BEA 16/116	VE 5-1	BER 16V	PM 26-23
0.18	0.72	MS116-1.00 1SAM 250 000 R1005	0.63 - 1.00	12	2 x A9-30-10 1SBL 141 001 R□□10	1	BEA 16/116	VE 5-1	BER 16V	PM 26-23
0.25	0.83	MS116-1.00 1SAM 250 000 R1005	0.63 - 1.00	12	2 x A9-30-10 1SBL 141 001 R□□10	1	BEA 16/116	VE 5-1	BER 16V	PM 26-23
0.37	1.12	MS116-1.60 1SAM 250 000 R1006	1.00 - 1.60	19.2	2 x A9-30-10 1SBL 141 001 R□□10	1.6	BEA 16/116	VE 5-1	BER 16V	PM 26-23
0.55	1.45	MS116-1.60 1SAM 250 000 R1006	1.00 - 1.60	19.2	2 x A9-30-10 1SBL 141 001 R□□10	1.6	BEA 16/116	VE 5-1	BER 16V	PM 26-23
0.75	1.9	MS116-2.50 1SAM 250 000 R1007	1.60 - 2.50	30	2 x A9-30-10 1SBL 141 001 R□□10	2.5	BEA 16/116	VE 5-1	BER 16V	PM 26-23
1.1	2.59	MS116-4.00 1SAM 250 000 R1008	2.50 - 4.00	48	2 x A16-30-10 1SBL 181 001 R□□10	4	BEA 16/116	VE 5-1	BER 16V	PM 26-23
1.5	3.45	MS116-4.00 1SAM 250 000 R1008	2.50 - 4.00	48	2 x A16-30-10 1SBL 181 001 R□□10	4	BEA 16/116	VE 5-1	BER 16V	PM 26-23
2.2	4.8	MS116-6.30 1SAM 250 000 R1009	4.00 - 6.30	75.6	2 x A16-30-10 1SBL 181 001 R□□10	6.3	BEA 16/116	VE 5-1	BER 16V	PM 26-23
3	6.48	MS116-10.0 1SAM 250 000 R1010	6.30 - 10.0	120	2 x A26-30-10 1SBL 241 001 R□□10	10	BEA 26/116	VE 5-1	BER 40V	PM 26-23
4	8.6	MS116-10.0 1SAM 250 000 R1010	6.30 - 10.0	120	2 x A26-30-10 1SBL 241 001 R□□10	10	BEA 26/116	VE 5-1	BER 40V	PM 26-23
5.5	11.1	MS116-12.0 1SAM 250 000 R1012	8.00 - 12.0	144	2 x A26-30-10 1SBL 241 001 R□□10	12	BEA 26/116	VE 5-1	BER 40V	PM 26-23
7.5	14.8	MS116-16.0 1SAM 250 000 R1011	10.0 - 16.0	192	2 x A26-30-10 1SBL 241 001 R□□10	16	BEA 26/116	VE 5-1	BER 40V	PM 26-23

Ordering Details - Main Accessories

Description	Type	Order Code	Pack ^{ing} pieces	Weight kg
Connecting links	BEA 16/116	1SBN 081 406 R1000	10	0.020
	BEA 26/116	1SBN 082 406 R1000	10	0.024
	BEA 26/325	1SBN 082 406 R1001	10	0.031
	BEA 40/450	1SBN 083 206 R1000	1	0.061
	BEA 50/450	1SBN 083 506 R1000	1	0.062
	BEA 75/495	1SBN 084 106 R1000	1	0.120
	BEA 110/495	1SBN 084 506 R1000	1	0.124
Connection kit	BSA 325	FPTN 472 772 R0001	1	0.009
Mechanical interlock unit	VM 5-1	1SBN 030 100 R1000	1	0.066
Mechanical & electrical interlock units	VE 5-1	1SBN 030 110 R1000	1	0.076
	VE 5-2	1SBN 030 210 R1000	1	0.146
Connection sets	BER 16V	1SBN 081 411 R1000	1	0.045
	BER 40V	1SBN 082 411 R1000	1	0.085
	BEM 75-30	1SBN 083 501 R1000	1	0.243
	BEM 110-30	1SFN 084 301 R1000	1	0.450
Mounting plate	PM 26-23	1SBN 091 407 R1000	1	0.330

>> Coil Voltage Codespages 0/1, 0/2 in the Cover Flap
 >> Accessories, Ordering Details page 57
 >> Other Manual Motor Starters and Contactors Main Catalogue



Reversing Starters Protected by Manual Motor Starter

Coordination Type 2

Ordering Details - Coordination type 2, 400 V, 50 kA, 50/60 Hz

IEC		Manual Motor Starter			Contactor		Accessories			
AC-3, 400 V Rated power kW	Rated current A	Type	Current setting range A	Magnetic tripping current A	Type	Allowed Setting current A	Connecting link between MS.. and contactors	Interlock unit	Connection set for the contactors	Mounting plate
		Order Code			Order Code					
		Unit piece			state coil voltage <input type="checkbox"/> <input type="checkbox"/> <input type="checkbox"/> <input type="checkbox"/>					
		Unit piece			state coil voltage code <input type="checkbox"/> <input type="checkbox"/>					
0.06	0.22	MS116-0.25 1SAM 250 000 R1002	0.16 - 0.25	3	2 x A9-30-10 <input type="checkbox"/> <input type="checkbox"/> <input type="checkbox"/> <input type="checkbox"/> 1SBL 141 001 R <input type="checkbox"/> <input type="checkbox"/> 10	0.25	BEA 16/116	VE 5-1	BER 16V	PM 26-23
0.09	0.34	MS116-0.40 1SAM 250 000 R1003	0.25 - 0.40	4.8	2 x A9-30-10 <input type="checkbox"/> <input type="checkbox"/> <input type="checkbox"/> <input type="checkbox"/> 1SBL 141 001 R <input type="checkbox"/> <input type="checkbox"/> 10	0.4	BEA 16/116	VE 5-1	BER 16V	PM 26-23
0.12	0.44	MS116-0.63 1SAM 250 000 R1004	0.40 - 0.63	7.56	2 x A9-30-10 <input type="checkbox"/> <input type="checkbox"/> <input type="checkbox"/> <input type="checkbox"/> 1SBL 141 001 R <input type="checkbox"/> <input type="checkbox"/> 10	0.63	BEA 16/116	VE 5-1	BER 16V	PM 26-23
0.18	0.72	MS116-1.00 1SAM 250 000 R1005	0.63 - 1.00	12	2 x A9-30-10 <input type="checkbox"/> <input type="checkbox"/> <input type="checkbox"/> <input type="checkbox"/> 1SBL 141 001 R <input type="checkbox"/> <input type="checkbox"/> 10	1	BEA 16/116	VE 5-1	BER 16V	PM 26-23
0.25	0.83	MS116-1.00 1SAM 250 000 R1005	0.63 - 1.00	12	2 x A9-30-10 <input type="checkbox"/> <input type="checkbox"/> <input type="checkbox"/> <input type="checkbox"/> 1SBL 141 001 R <input type="checkbox"/> <input type="checkbox"/> 10	1	BEA 16/116	VE 5-1	BER 16V	PM 26-23
0.37	1.12	MS116-1.60 1SAM 250 000 R1006	1.00 - 1.60	19.2	2 x A9-30-10 <input type="checkbox"/> <input type="checkbox"/> <input type="checkbox"/> <input type="checkbox"/> 1SBL 141 001 R <input type="checkbox"/> <input type="checkbox"/> 10	1.6	BEA 16/116	VE 5-1	BER 16V	PM 26-23
0.55	1.45	MS116-1.60 1SAM 250 000 R1006	1.00 - 1.60	19.2	2 x A9-30-10 <input type="checkbox"/> <input type="checkbox"/> <input type="checkbox"/> <input type="checkbox"/> 1SBL 141 001 R <input type="checkbox"/> <input type="checkbox"/> 10	1.6	BEA 16/116	VE 5-1	BER 16V	PM 26-23
0.75	1.9	MS116-2.50 1SAM 250 000 R1007	1.60 - 2.50	30	2 x A9-30-10 <input type="checkbox"/> <input type="checkbox"/> <input type="checkbox"/> <input type="checkbox"/> 1SBL 141 001 R <input type="checkbox"/> <input type="checkbox"/> 10	2.5	BEA 16/116	VE 5-1	BER 16V	PM 26-23
1.1	2.59	MS116-4.00 1SAM 250 000 R1008	2.50 - 4.00	48	2 x A16-30-10 <input type="checkbox"/> <input type="checkbox"/> <input type="checkbox"/> <input type="checkbox"/> 1SBL 181 001 R <input type="checkbox"/> <input type="checkbox"/> 10	4	BEA 16/116	VE 5-1	BER 16V	PM 26-23
1.5	3.45	MS116-4.00 1SAM 250 000 R1008	2.50 - 4.00	48	2 x A16-30-10 <input type="checkbox"/> <input type="checkbox"/> <input type="checkbox"/> <input type="checkbox"/> 1SBL 181 001 R <input type="checkbox"/> <input type="checkbox"/> 10	4	BEA 16/116	VE 5-1	BER 16V	PM 26-23
2.2	4.8	MS116-6.30 1SAM 250 000 R1009	4.00 - 6.30	75.6	2 x A16-30-10 <input type="checkbox"/> <input type="checkbox"/> <input type="checkbox"/> <input type="checkbox"/> 1SBL 181 001 R <input type="checkbox"/> <input type="checkbox"/> 10	6.3	BEA 16/116	VE 5-1	BER 16V	PM 26-23
3	6.6	MS325-9.00 1SAM 150 000 R1010	6.30 - 9.00	135	2 x A26-30-10 <input type="checkbox"/> <input type="checkbox"/> <input type="checkbox"/> <input type="checkbox"/> 1SBL 241 001 R <input type="checkbox"/> <input type="checkbox"/> 10	9	BEA 26/325	VE 5-1	BER 40V	PM 26-23
4	8.5	MS325-9.00 1SAM 150 000 R1010	6.30 - 9.00	135	2 x A26-30-10 <input type="checkbox"/> <input type="checkbox"/> <input type="checkbox"/> <input type="checkbox"/> 1SBL 241 001 R <input type="checkbox"/> <input type="checkbox"/> 10	9	BEA 26/325	VE 5-1	BER 40V	PM 26-23
5.5	11.5	MS325-12.5 1SAM 150 000 R1011	9.00 - 12.5	187.5	2 x A26-30-10 <input type="checkbox"/> <input type="checkbox"/> <input type="checkbox"/> <input type="checkbox"/> 1SBL 241 001 R <input type="checkbox"/> <input type="checkbox"/> 10	12.5	BEA 26/325	VE 5-1	BER 40V	PM 26-23
7.5	15.5	MS325-16.0 1SAM 150 000 R1012	12.5 - 16.0	240	2 x A26-30-10 <input type="checkbox"/> <input type="checkbox"/> <input type="checkbox"/> <input type="checkbox"/> 1SBL 241 001 R <input type="checkbox"/> <input type="checkbox"/> 10	16	BEA 26/325	VE 5-1	BER 40V	PM 26-23
9	18.3	MS325-20.0 1SAM 150 000 R1013	16.0 - 20.0	300	2 x A26-30-10 <input type="checkbox"/> <input type="checkbox"/> <input type="checkbox"/> <input type="checkbox"/> 1SBL 241 001 R <input type="checkbox"/> <input type="checkbox"/> 10	20	BEA 26/325	VE 5-1	BER 40V	PM 26-23
11	22	MS325-25.0 1SAM 150 000 R1014	20.0 - 25.0	375	2 x A30-30-10 <input type="checkbox"/> <input type="checkbox"/> <input type="checkbox"/> <input type="checkbox"/> 1SBL 281 001 R <input type="checkbox"/> <input type="checkbox"/> 10	25	BSA 325	VE 5-1	BER 40V	-
15	30	MS450-32.0 1SAM 450 000 R1004	22.0 - 32.0	384	2 x A40-30-10 <input type="checkbox"/> <input type="checkbox"/> <input type="checkbox"/> <input type="checkbox"/> 1SBL 321 001 R <input type="checkbox"/> <input type="checkbox"/> 10	30	BEA 40/450	VE 5-1	BER 40V	-
18.5	37	MS450-40.0 1SAM 450 000 R1005	28.0 - 40.0	480	2 x A40-30-10 <input type="checkbox"/> <input type="checkbox"/> <input type="checkbox"/> <input type="checkbox"/> 1SBL 321 001 R <input type="checkbox"/> <input type="checkbox"/> 10	38	BEA 40/450	VE 5-1	BER 40V	-
22	44	MS450-50.0 1SAM 450 000 R1007	40.0 - 50.0	600	2 x A63-30-00 <input type="checkbox"/> <input type="checkbox"/> <input type="checkbox"/> <input type="checkbox"/> 1SBL 371 001 R <input type="checkbox"/> <input type="checkbox"/> 00	47.5	BEA 50/450	VE 5-2	BEM 75-30	-
30	60	MS495-63.0 1SAM 550 000 R1007	45.0 - 63.0	756	2 x A75-30-00 <input type="checkbox"/> <input type="checkbox"/> <input type="checkbox"/> <input type="checkbox"/> 1SBL 411 001 R <input type="checkbox"/> <input type="checkbox"/> 00	60	BEA 75/495	VE 5-2	BEM 75-30	-
37	72	MS495-75.0 1SAM 550 000 R1008	57.0 - 75.0	900	2 x A75-30-00 <input type="checkbox"/> <input type="checkbox"/> <input type="checkbox"/> <input type="checkbox"/> 1SBL 411 001 R <input type="checkbox"/> <input type="checkbox"/> 00	72.5	BEA 75/495	VE 5-2	BEM 75-30	-
45	85	MS495-90.0 1SAM 550 000 R1009	70.0 - 90.0	1080	2 x A95-30-00 <input type="checkbox"/> <input type="checkbox"/> <input type="checkbox"/> <input type="checkbox"/> 1SFL 431 001 R <input type="checkbox"/> <input type="checkbox"/> 00	85	BEA 110/495	VE 5-2	BEM 110-30	-
51	94	MS495-100 1SAM 550 000 R1010	80.0 - 100	1200	2 x A95-30-00 <input type="checkbox"/> <input type="checkbox"/> <input type="checkbox"/> <input type="checkbox"/> 1SFL 431 001 R <input type="checkbox"/> <input type="checkbox"/> 00	96	BEA 110/495	VE 5-2	BEM 110-30	-

>> Coil Voltage Codes pages 0/1, 0/2 in the Cover Flap
 >> Accessories, Ordering Details page 57
 >> Other Manual Motor Starters and Contactors Main Catalogue



Direct-On-Line Starters Open Type Version in Kit Form

Protection by Manual Motor Starter

Wiring Diagrams

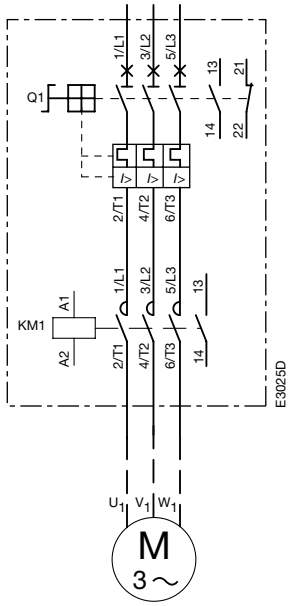

Power Circuit

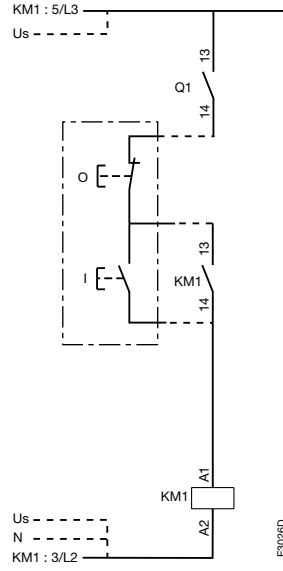

Remote Control

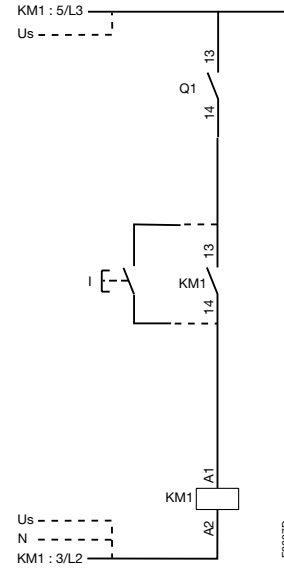

Local Control

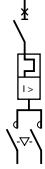

Reversing Starters

Open Type Version in Kit Form

Protection by Manual Motor Starter

Wiring Diagrams for Reversing Starters

With or without VM 5-1 mechanical interlock unit, electrical interlocking by built-in auxiliary contacts

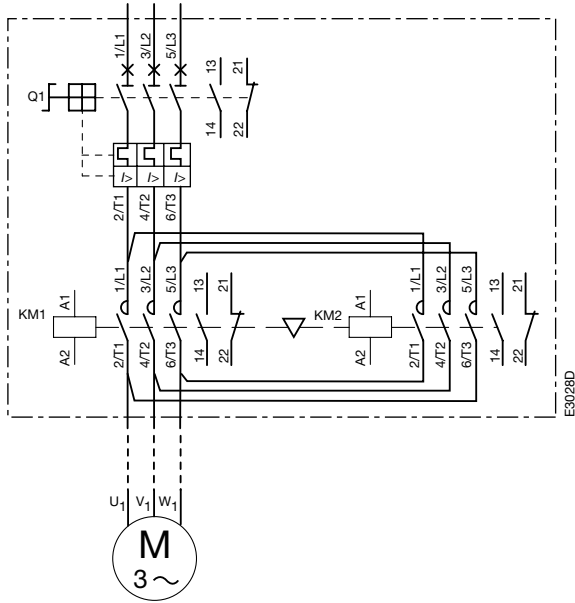

Power Circuit

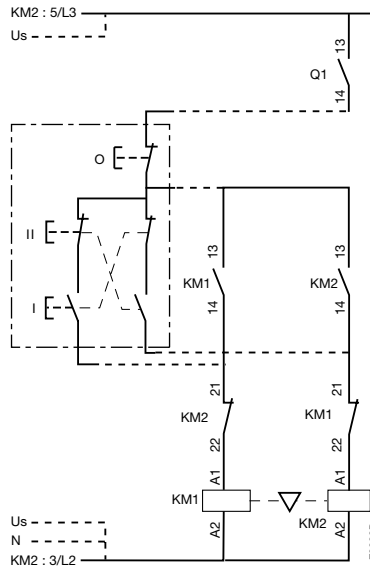

Remote Control

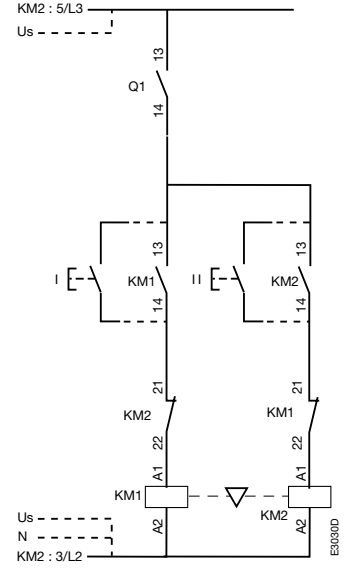

Local Control

Wiring Diagrams for Reversing Starters

With VE 5-... mechanical and electrical interlock unit

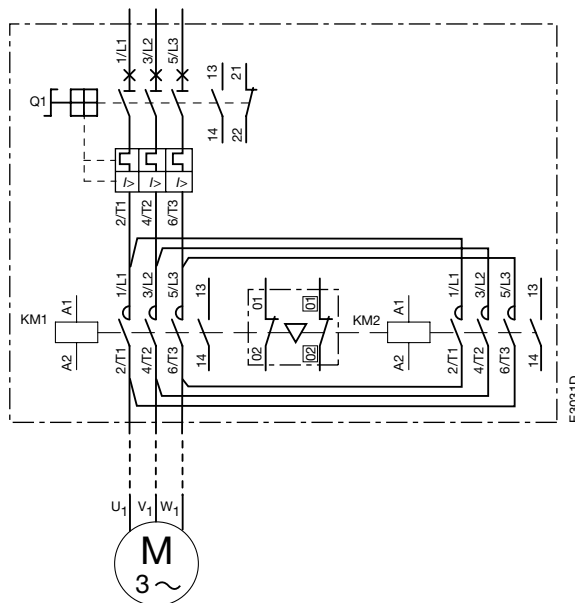

Power Circuit

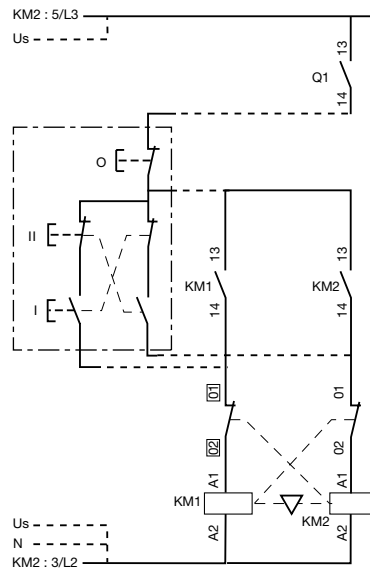

Remote Control

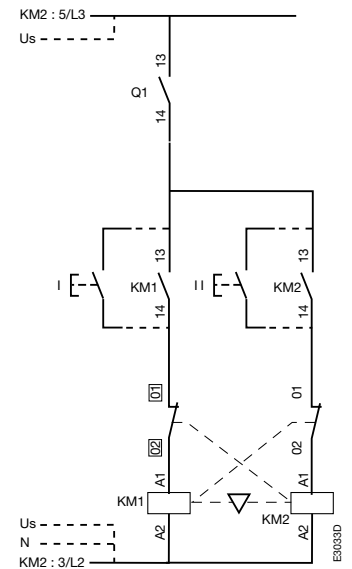

Local Control



A 9 ... A 26 3-pole Contactors Protected by Manual Motor Starter

Direct-On-Line Starter

Dimensions (in mm)

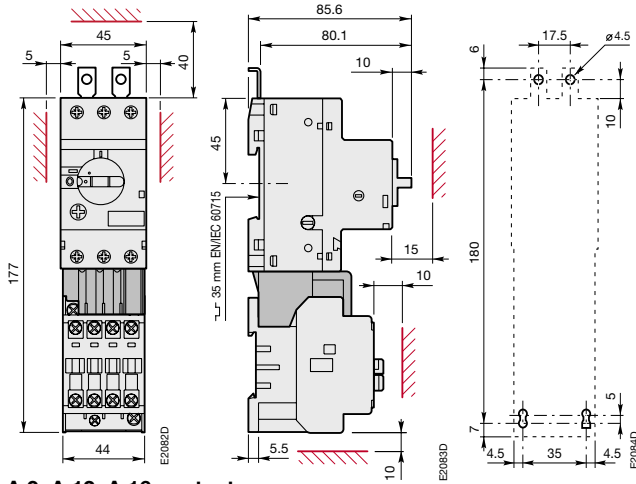

**A 9, A 12, A 16 contactors
+ BEA 16/116
+ MS 116**

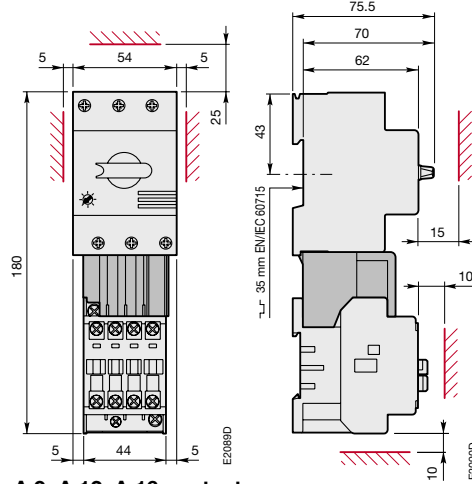

**A 9, A 12, A 16 contactors
+ BEA 16/325
+ MS 325**

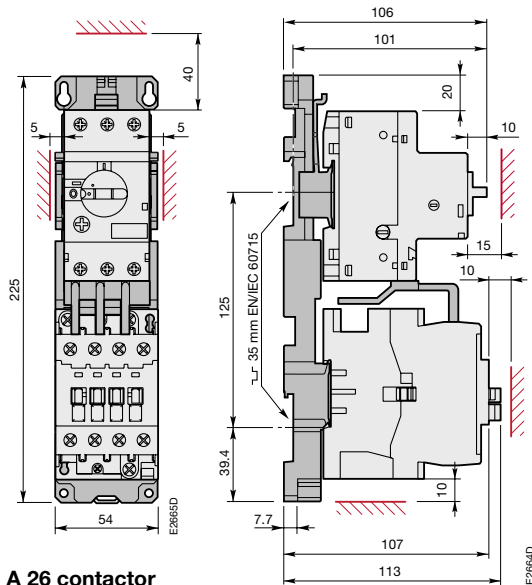

**A 26 contactor
+ BEA 26/116
+ MS 116 + PM 26-13**

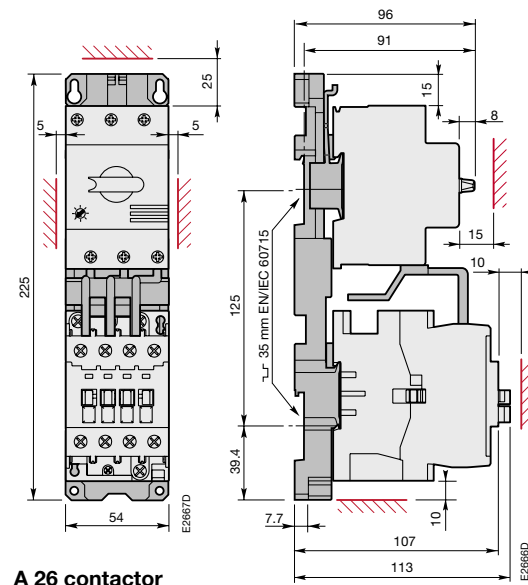

**A 26 contactor
+ BEA 26/325
+ MS 325 + PM 26-13**

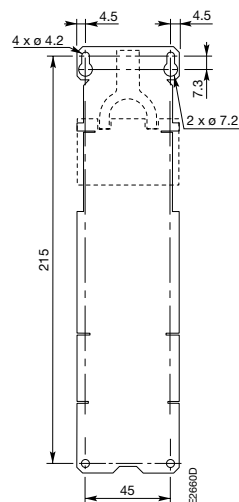

A 26 contactor + BEA.. + MS.. + PM 26-13 Drilling plan



A 50, A 63 3-pole Contactors Protected by Manual Motor Starter

Direct-On-Line Starter

Dimensions (in mm)

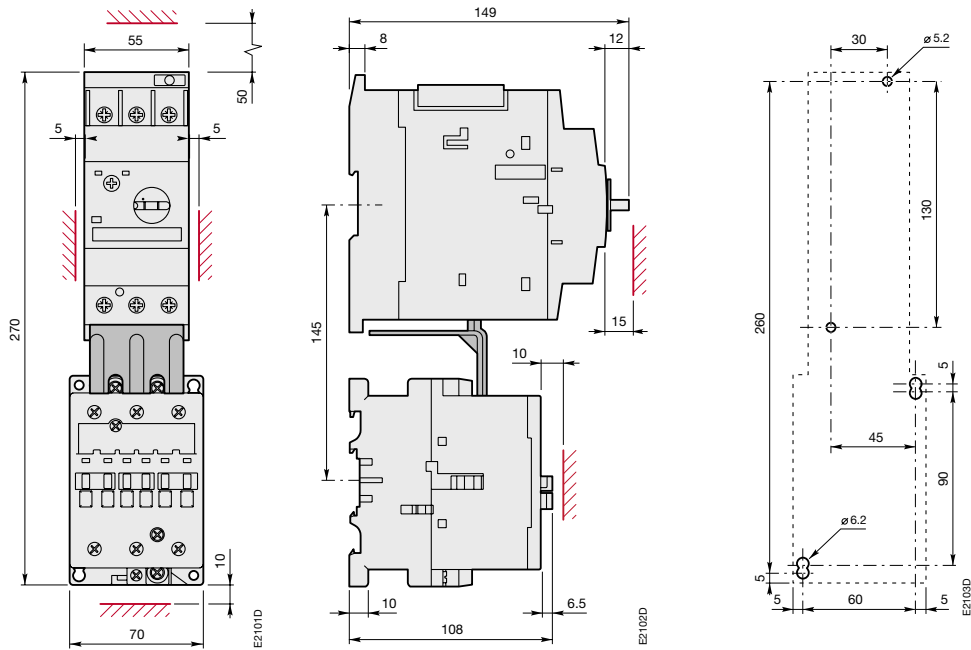

A 50, A 63 contactors
+ BEA 50/450
+ MS 450



A 63 ... A 110 3-pole Contactors Protected by Manual Motor Starter Direct-On-Line Starter

Dimensions (in mm)

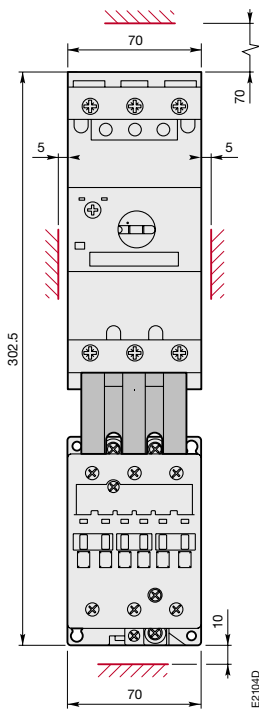

E2104D

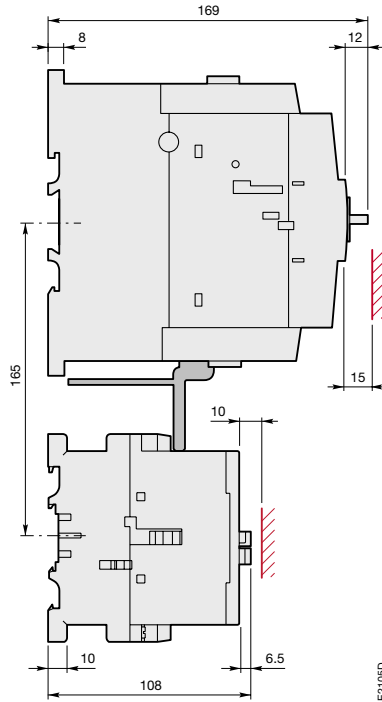

E2103D

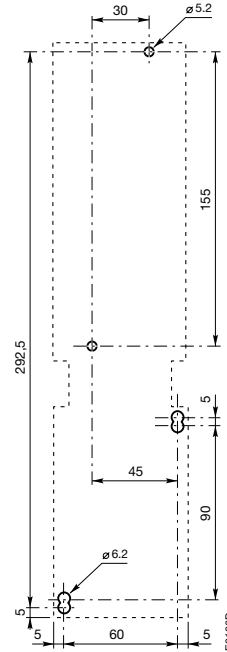

E2108D

A 63, A 75 contactors
+ BEA 75/495
+ MS 495

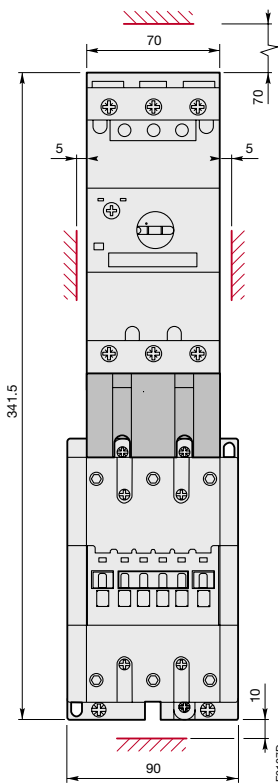

E2107D

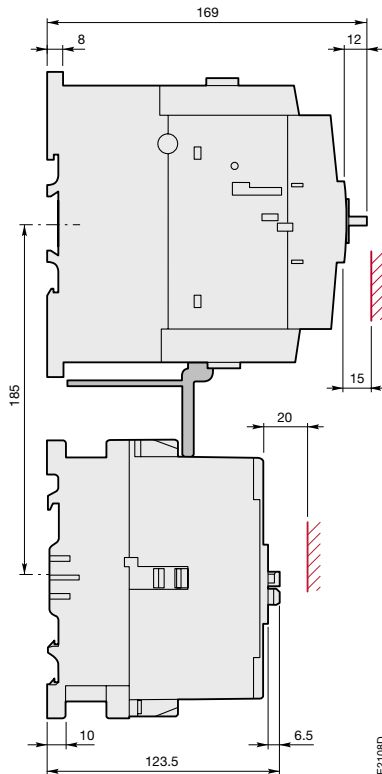

E2108D

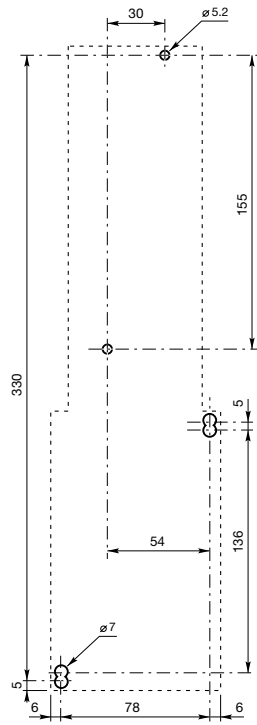

E2109D

A 95, A 110 contactors
+ BEA 110/495
+ MS 495

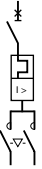

A 9 ... A 16 3-pole Contactors Protected by Manual Motor Starter Reversing Starter

Dimensions (in mm)

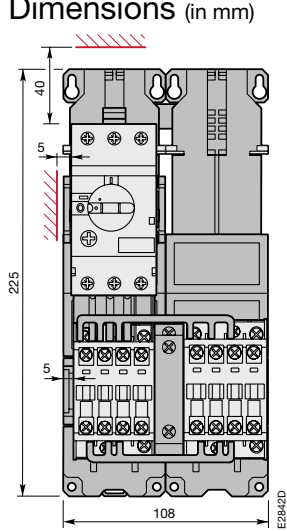

**A 9, A 12, A 16 contactors
+ VM/VE 5-1
+ BEA 16/116 + BER 16V
+ MS 116 + PM 26-23**

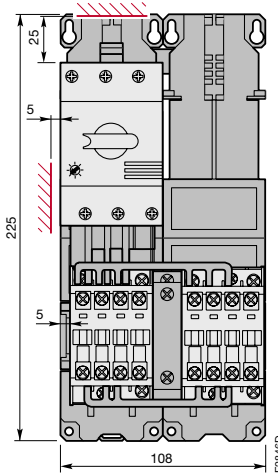
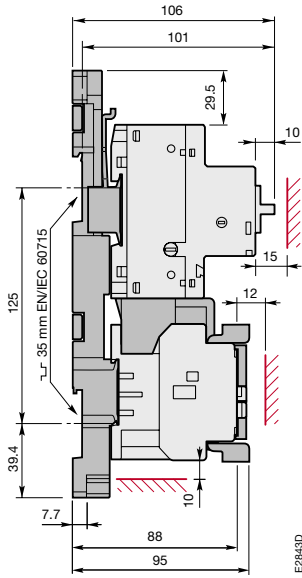

**A 9, A 12, A 16 contactors
+ VM/VE 5-1
+ BEA 16/325 + BER 16V
+ MS 325 + PM 26-23**

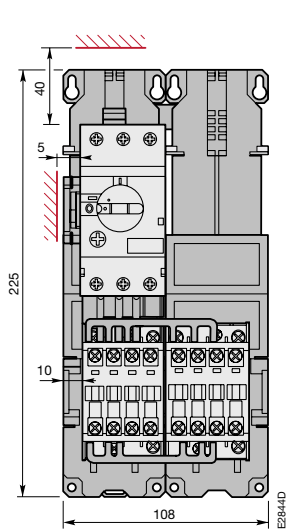
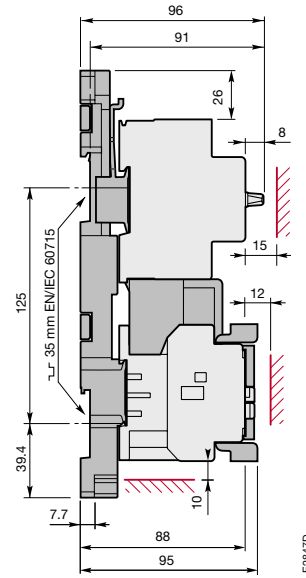

**A 9, A 12, A 16 contactors
+ BEA 16/116 + BER 16
+ MS 116 + PM 26-23**

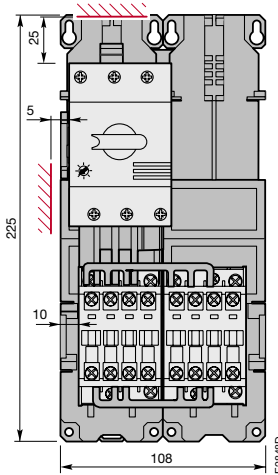
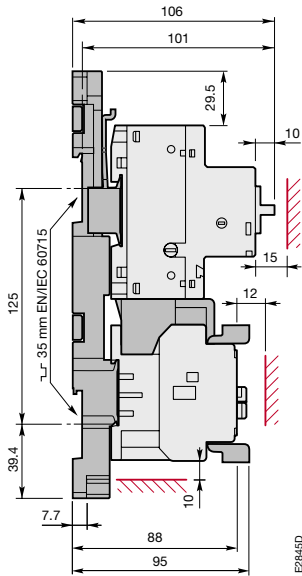

**A 9, A 12, A 16 contactors
+ BEA 16/325 + BER 16
+ MS 325 + PM 26-23**

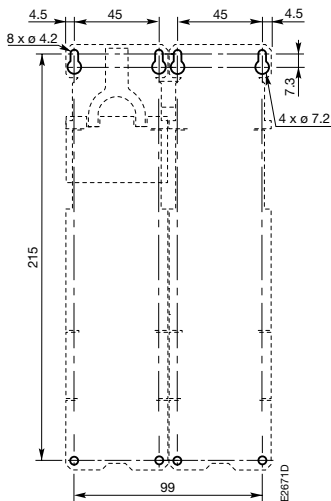
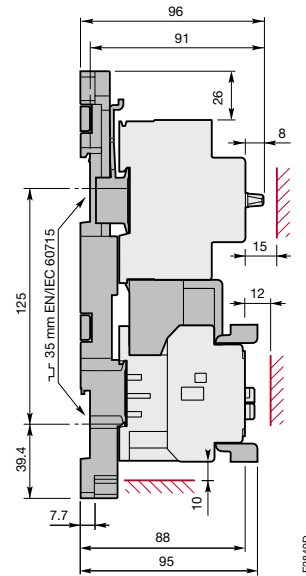

A 9, A 12, A 16 + BEA.. + MS... + PM 26-23 Drilling plan

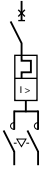

A 26 3-pole Contactors Protected by Manual Motor Starter Reversing Starter

Dimensions (in mm)

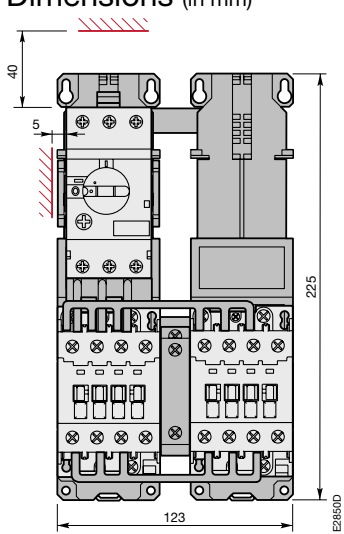

**A 26 contactors
+ VM/VE 5-1
+ BEA 26/116 + BER 40V
+ MS 116 + PM 26-23**

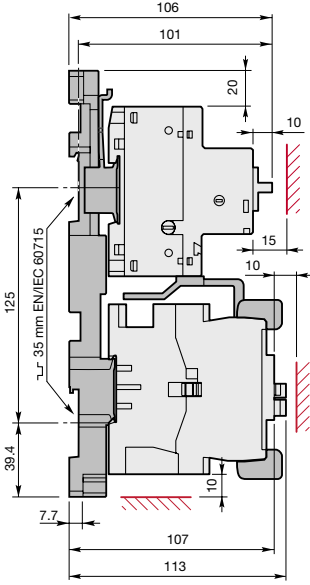

**A 26 contactors
+ VM/VE 5-1
+ BEA 26/325 + BER 40V
+ MS 325 + PM 26-23**

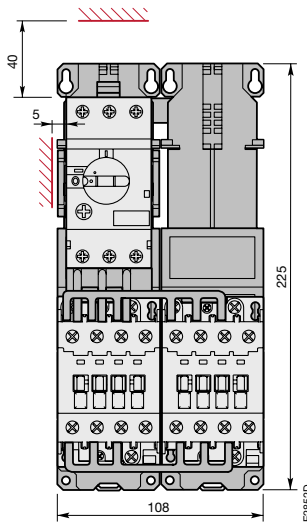
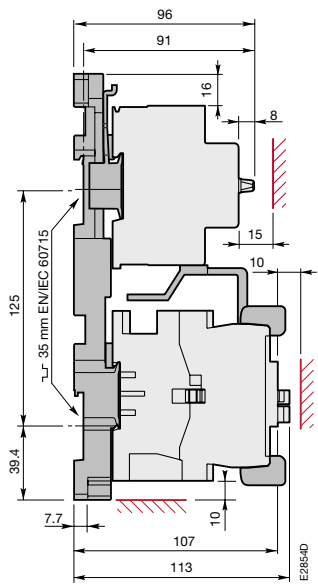
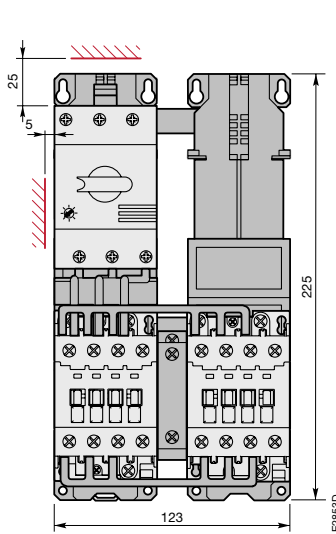

**A 26 contactors
+ BEA 26/116 + BER 40
+ MS 116 + PM 26-23**

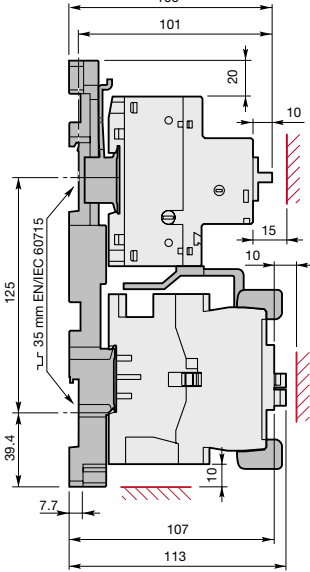

**A 26 contactors
+ BEA 26/325 + BER 40
+ MS 325 + PM 26-23**

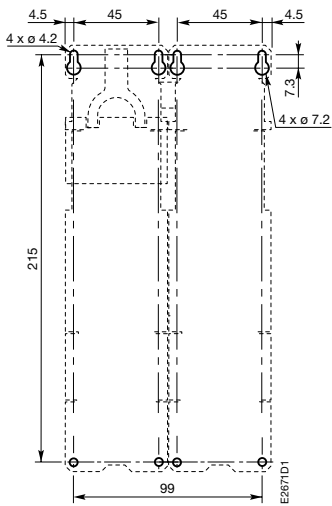
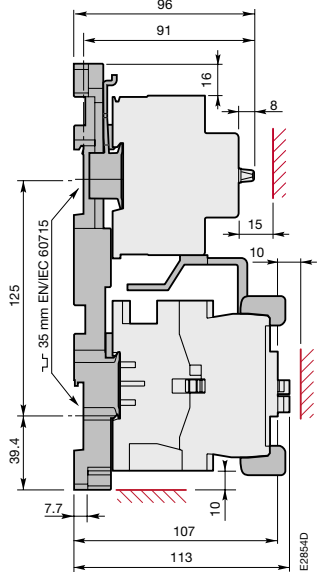
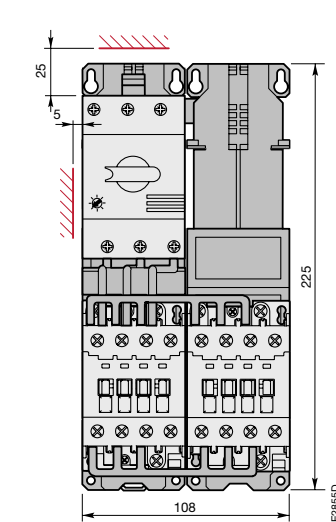

A 26 + BEA... + MS... + PM 26-23 Drilling plan

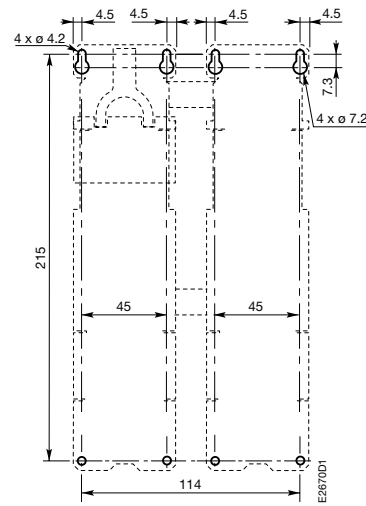

A 26 + VM/VE 5-1 + BEA... + MS... + PM 26-23 Drilling plan



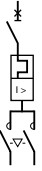

A 30, A 40 3-pole Contactors Protected by Manual Motor Starter Reversing Starter

Dimensions (in mm)

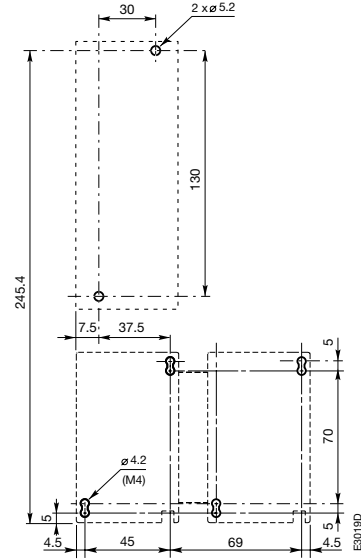
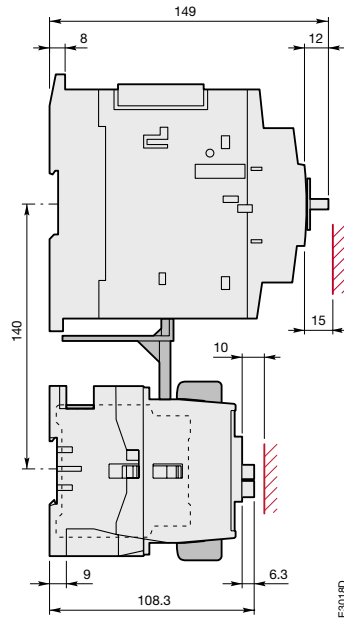
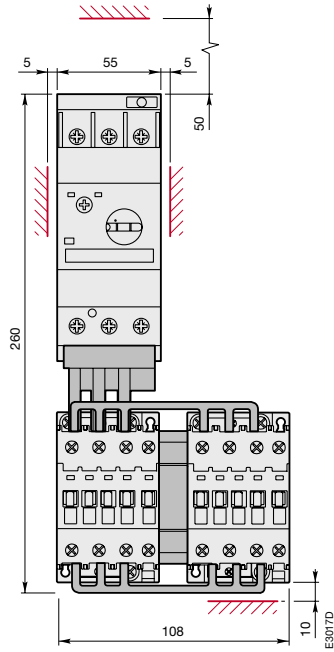

A 30, A 40 contactors
+ VM/VE 5-1
+ BEA 40/450 + BER 40V
+ MS 450

Drilling plan

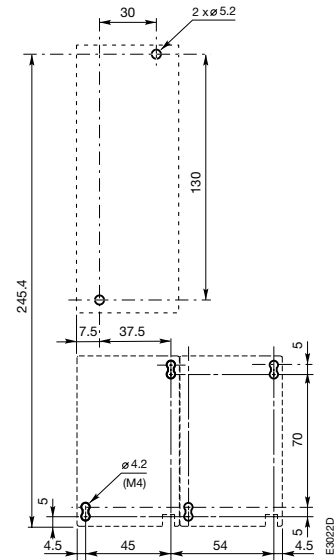
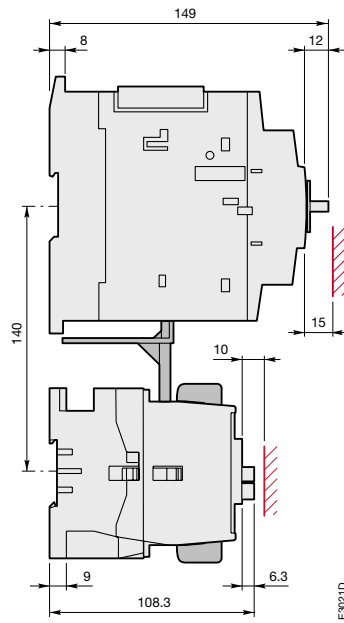
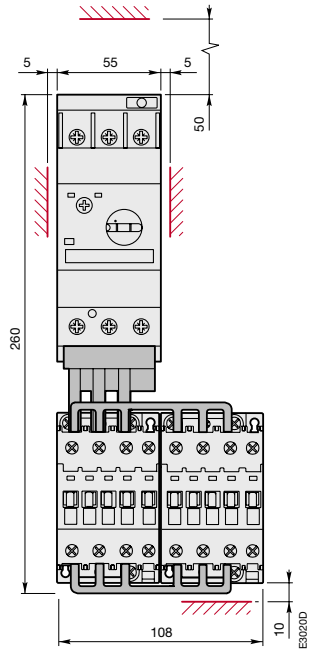

A 30, A 40 contactors
+ BEA 40/450 + BER 40
+ MS 450

Drilling plan

Notes



The page contains a series of horizontal lines for writing, starting from a red line and continuing down to the footer area.

Starting Solution with Bus-bar System **smissline-S**

Direct-On-Line and Reversing Starters with Manual Motor Starters up to 11 kW

Compact and flexible solution

The smissline Bus-bar System offers the efficient, flexible and rapid mounting of components. The socket bases can be combined in any order. The bus-bars are fitted to the 6 and 8-way modular sockets (and additional sockets) and according to requirements. The advantage of the Combi moduls is that any desired combinations of smissline units can be formed into a unit with conventional devices. These can be replaced very quickly and keeps the downtime of systems to a minimum.

Motor starter solution

The direct and reversing starters are possible up to 11 kW with A9 to A26 contactors associated to MS116 or MS325 manual motor starter with a BEA connecting link, and fixed on a single combi-modul.

The use of one single combi-modul with one combi-modul without wire (ref ZLS840) allows the possibility to assemble a reversing starter. The product selection according to the coordination tables is detailed in the catalogue tables (see page 12 to 21)

Your advantage:

- Keep the downtime of systems to a minimum
- Components interchangeable at any time
- Compact energy distribution - up to max. 200 A (150 A)
- Full scope for the future
- Completely touch proof
- Easy maintenance

For complete information on the smissline system, please consult the specific catalogue or the ABB website.

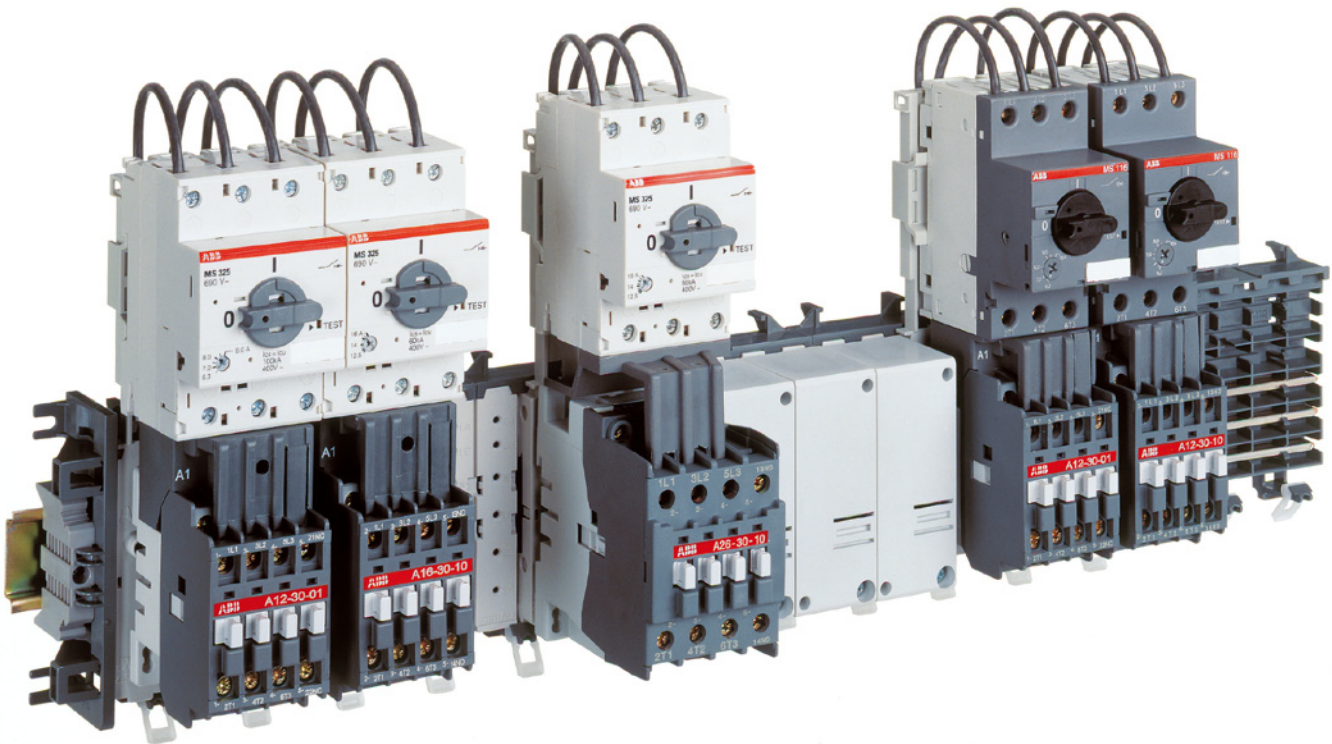

Starting Solution with Bus-bar System *smisline-S*

Combi Modul and Accessories

Technical data IEC/EN60439-2

Rated voltage U_e :	400/690 V
Rated short-time withstand current I_{cw} :	10 kA / 300 ms
Rated current I_n :	32 A (L1, L2, L3, N) - 6 A (La, Lb auxiliary circuits)
Moduls:	3 (54 mm)
Approbation:	CE, IEC / EN60439-2

Ordering details

Description	Modules	Type	Order code	Pack ^{ing} unit	Weight kg
Combi-modul wire top feed					
Combi-modul single containing L1, L2, L3 top feed	3	ZLS8403LWT-S	2CCA 180 451 R0001	1	0.085
Combi-modul single containing L1, L2, L3, N top feed	3	ZLS8403LNWT-S	2CCA 180 452 R0001	1	0.090
Combi-modul single containing L1, L2, L3 top feed, La	3	ZLS8403LAWT-S	2CCA 180 470 R0001	1	0.090
Combi-modul single containing L1, L2, L3 top feed, La, Lb	3	ZLS8403LABWT-S	2CCA 180 453 R0001	1	0.095
Combi-modul single containing L1, L2, L3, N top feed, La	3	ZLS8403LNAWT-S	2CCA 180 471 R0001	1	0.095
Combi-modul single containing L1, L2, L3, N top feed, La, Lb	3	ZLS8403LNABWT-S	2CCA 180 454 R0001	1	0.100
Combi-modul wire bottom feed					
Combi-modul single containing L1, L2, L3 bottom feed	3	ZLS8403LWB-S	2CCA 180 462 R0001	1	0.085
Combi-modul single containing L1, L2, L3, N bottom feed	3	ZLS8403LNWB-S	2CCA 180 463 R0001	1	0.090
Combi-modul single containing L1, L2, L3 bottom feed, La	3	ZLS8403LAWB-S	2CCA 180 472 R0001	1	0.090
Combi-modul single containing L1, L2, L3 bottom feed, La, Lb	3	ZLS8403LABWB-S	2CCA 180 464 R0001	1	0.095
Combi-modul single containing L1, L2, L3, N bottom feed, La	3	ZLS8403LNAWB-S	2CCA 180 473 R0001	1	0.095
Combi-modul single containing L1, L2, L3, N bottom feed, La, Lb	3	ZLS8403LNABWB-S	2CCA 180 465 R0001	1	0.100
Combi-modul without plug-in contacts					
Combi-modul without wire		ZLS840	2CCA 180 450 R0001	1	0.045
Accessories Combi-modul					
Connecting element for combi-modul (3 connectors per module) - bag of 12		ZLS519	2CCA 017 429 R0001	1 bag	-
Fixing for contactor and motor protection circuit-breaker - bag of 10		ZLS518	2CCF 002 792 R0001	1 bag	0.020
Fixing for contactor - bag of 10		ZLS522	2CCF 017 540 R0001	1 bag	0.030

Dimensions

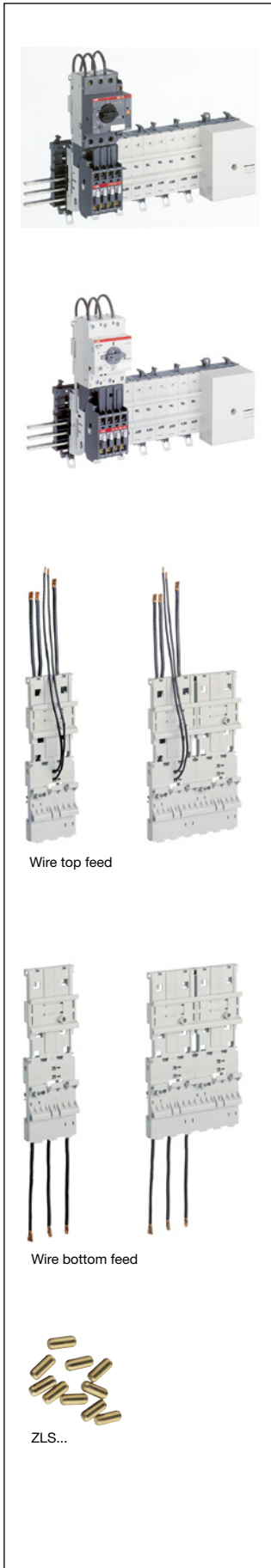
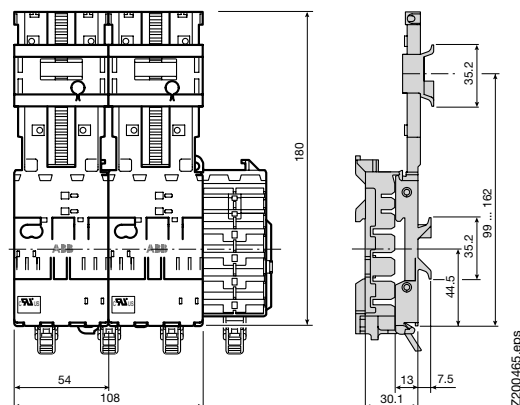

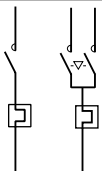

Direct-On-Line and Reversing Starters Open Type Version, in Kit Form

Protected by Thermal Overload Relay

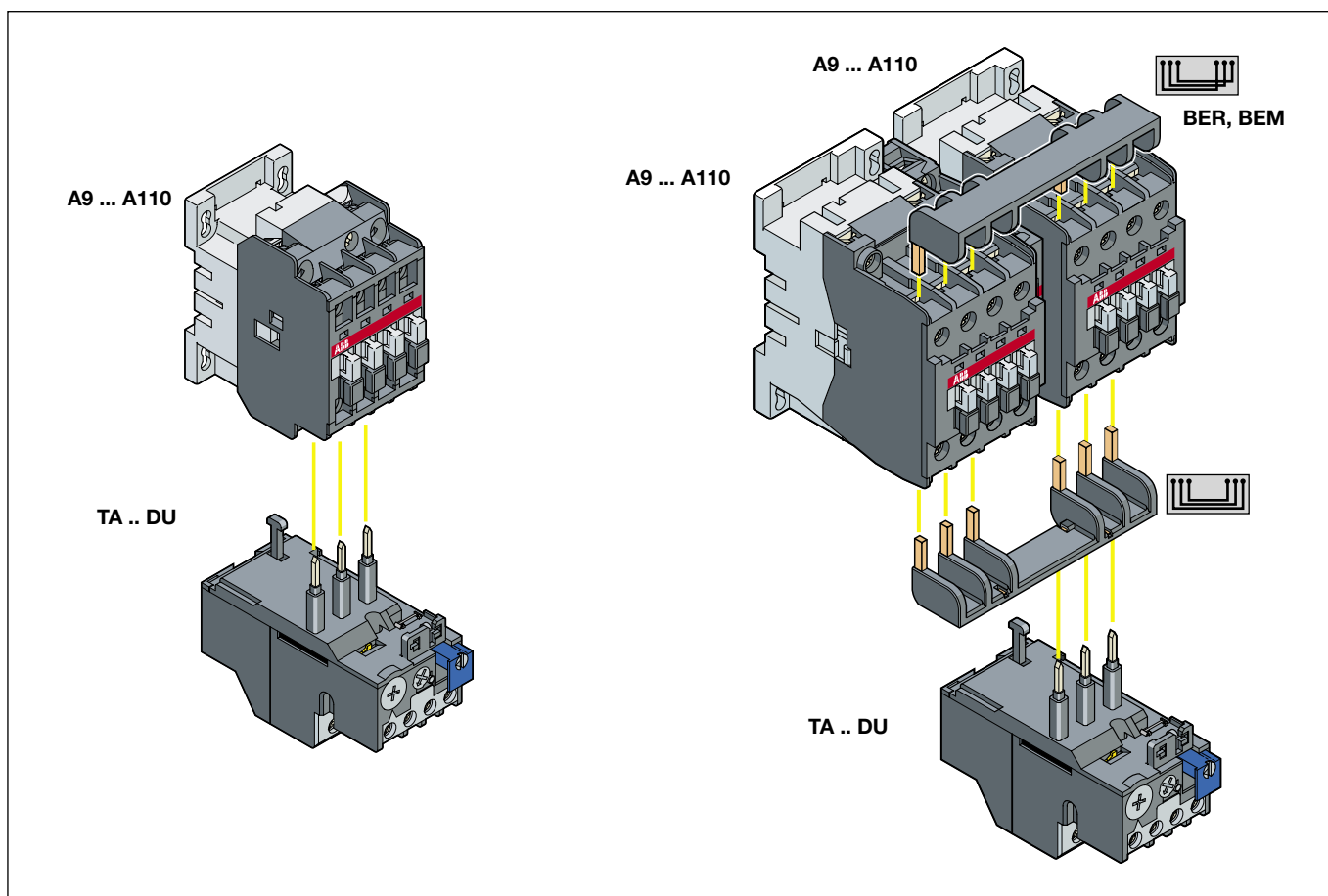

Direct-On-Line Starters

3-pole a.c. operated contactors	A 9	A 12	A 16	A 26	A 30	A 40	A 50	A 63	A 75	A 95	A 110
Thermal overload relays	TA 25 DU 0.1 ... 0.16 A to 24 ... 32 A						TA 75 DU 18 ... 25 A to 60 ... 80 A			TA 80 DU 29 ... 42 A to 60 ... 80 A	
	TA 42 DU 18 ... 25 A to 29 ... 42 A									TA 110 DU 65 ... 90 A to 80 ... 110 A	

Reversing Starters

3-pole a.c. operated contactors	A 9	A 12	A 16	A 26	A 30	A 40	A 50	A 63	A 75	A 95	A 110
Connection sets	BER 16V ⁽¹⁾			BER 40V ⁽¹⁾			BEM 75-30			BEM 110-30	
Thermal overload relays	TA 25 DU 0.1 ... 0.16 A to 24 ... 32 A						TA 75 DU 18 ... 25 A to 60 ... 80 A			TA 80 DU 29 ... 42 A to 60 ... 80 A	
	TA 42 DU 18 ... 25 A to 29 ... 42 A									TA 110 DU 65 ... 90 A to 80 ... 110 A	
Mechanical / electrical interlock units	VM 5-1 / VE 5-1						VE 5-2				

(1) If only an electrical interlocking is required between contactors A 9 up to A 40, use BER 16 and BER 40 connection sets for contactors with N.C. built-in auxiliary contacts.

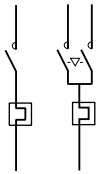

Direct-On-Line and Reversing Starters Open Type Version, in Kit Form

Protected by Thermal Overload Relay

Application

Direct-on-line and reversing starters for controlling three-phase asynchronous motors:

- for a maximum operational voltage up to 690 V - 50 or 60Hz
- for a switching frequency of ≤ 15 starts an hour with a load factor of 80 %
of ≤ 30 starts an hour with a load factor of 50 %
- with an ambient temperature near the devices of ≤ 55 °C

Coordination

See "Online Product Selection Tools" on "www.abb.com/lowvoltages" website.

Click on "Online Selected Optimized Coordinations" to display the required coordination table according to the short-circuit protection device and the coordination type complying with IEC/EN 60947-4-1.

Mounting and Connection Accessory Description

BER or BEM connection sets allow to assemble quickly reversing starters. These accessories eliminate the potential risk of wiring errors, reduce the time required to install and to maintain reversing starters.

For the reversing contactors the interlocking can be easily assured by a simple mounting between both contactors of:

- a VE 5-... interlock unit for a mechanical and electrical interlocking
- a VM 5-1 interlock unit for a mechanical interlocking and add-on N.C. aux. contacts for the electrical interlocking (or use contactors with built-in N.C. aux. contacts).

Note: If only an electrical interlocking is required between 3-pole contactors A 9 up to A 40, select contactors with add-on or built-in N.C. auxiliary contacts associated with BER 16 and BER 40 connection sets (A 9-30-01 ... A 40-30-01 contactors, see main catalogue).

Direct-On-Line Starters - Selection and Ordering Details

(for coil voltage codes and overload relay ranges, see pages 0/1 and 0/2 in the cover flap)

Rated Power	Contactor KM1 Type state coil voltage [] [] []	Thermal Overload Relay Type state max. setting range [] [] []
AC-3 kW	Order Code state coil voltage code [] []	Order Code state setting range code [] [] []
4	A 9-30-10 [] [] [] 1SBL 141 001 R [] [] [] 0	TA 25 DU [] [] [] 1SAZ 211 201 R10 [] [] []
5.5	A 12-30-10 [] [] [] 1SBL 161 001 R [] [] [] 0	TA 25 DU [] [] [] 1SAZ 211 201 R10 [] [] []
7.5	A 16-30-10 [] [] [] 1SBL 181 001 R [] [] [] 0	TA 25 DU [] [] [] 1SAZ 211 201 R10 [] [] []
11	A 26-30-10 [] [] [] 1SBL 241 001 R [] [] [] 0	TA 25 DU [] [] [] 1SAZ 211 201 R10 [] [] []
15	A 30-30-10 [] [] [] 1SBL 281 001 R [] [] [] 0	TA 25 DU [] [] [] 1SAZ 211 201 R10 [] [] []
18.5	A 40-30-10 [] [] [] 1SBL 321 001 R [] [] [] 0	TA 42 DU [] [] [] 1SAZ 311 201 R10 [] [] []
22	A 50-30-00 [] [] [] 1SBL 351 001 R [] [] [] 0 0	TA 75 DU [] [] [] 1SAZ 321 201 R10 [] [] []
30	A 63-30-00 [] [] [] 1SBL 371 001 R [] [] [] 0 0	TA 75 DU [] [] [] 1SAZ 321 201 R10 [] [] []
37	A 75-30-00 [] [] [] 1SBL 411 001 R [] [] [] 0 0	TA 75 DU [] [] [] 1SAZ 321 201 R10 [] [] []
45	A 95-30-00 [] [] [] 1SFL 431 001 R [] [] [] 0 0	TA 110 DU [] [] [] 1SAZ 411 201 R10 [] [] []
55	A 110-30-00 [] [] [] 1SFL 451 001 R [] [] [] 0 0	TA 110 DU [] [] [] 1SAZ 411 201 R10 [] [] []

Reversing Starters - Selection and Ordering Details

(for coil voltage codes and overload relay ranges, see pages 0/1 and 0/2 in the cover flap)

Rated Power	Contactors KM1 + KM2 Type state coil voltage [] [] []	Thermal Overload Relay Type state max. setting range [] [] []	Interlock Unit Type	Connection Set Type
AC-3 kW	Order Code state coil voltage code [] [] []	Order Code state setting range code [] [] []	Type	Type
4	2 x A 9-30-10 [] [] [] 1SBL 141 001 R [] [] [] 0	TA 25 DU [] [] [] 1SAZ 211 201 R10 [] [] []	VE 5-1	BER 16V
5.5	2 x A 12-30-10 [] [] [] 1SBL 161 001 R [] [] [] 0	TA 25 DU [] [] [] 1SAZ 211 201 R10 [] [] []	VE 5-1	BER 16V
7.5	2 x A 16-30-10 [] [] [] 1SBL 181 001 R [] [] [] 0	TA 25 DU [] [] [] 1SAZ 211 201 R10 [] [] []	VE 5-1	BER 16V
11	2 x A 26-30-10 [] [] [] 1SBL 241 001 R [] [] [] 0	TA 25 DU [] [] [] 1SAZ 211 201 R10 [] [] []	VE 5-1	BER 40V
15	2 x A 30-30-10 [] [] [] 1SBL 281 001 R [] [] [] 0	TA 25 DU [] [] [] 1SAZ 211 201 R10 [] [] []	VE 5-1	BER 40V
18.5	2 x A 40-30-10 [] [] [] 1SBL 321 001 R [] [] [] 0	TA 42 DU [] [] [] 1SAZ 311 201 R10 [] [] []	VE 5-1	BER 40V
22	2 x A 50-30-00 [] [] [] 1SBL 351 001 R [] [] [] 0 0	TA 75 DU [] [] [] 1SAZ 321 201 R10 [] [] []	VE 5-2	BEM 75-30
30	2 x A 63-30-00 [] [] [] 1SBL 371 001 R [] [] [] 0 0	TA 75 DU [] [] [] 1SAZ 321 201 R10 [] [] []	VE 5-2	BEM 75-30
37	2 x A 75-30-00 [] [] [] 1SBL 411 001 R [] [] [] 0 0	TA 75 DU [] [] [] 1SAZ 321 201 R10 [] [] []	VE 5-2	BEM 75-30
45	2 x A 95-30-00 [] [] [] 1SFL 431 001 R [] [] [] 0 0	TA 110 DU [] [] [] 1SAZ 411 201 R10 [] [] []	VE 5-2	BEM 110-30
55	2 x A 110-30-00 [] [] [] 1SFL 451 001 R [] [] [] 0 0	TA 110 DU [] [] [] 1SAZ 411 201 R10 [] [] []	VE 5-2	BEM 110-30

Ordering Details - Main Accessories

Description	Type	Order Code	Pack ^{ing} pieces	Weight kg
Mechanical interlock unit	VM 5-1	1SBN 030 100 R1000	1	0.066
Mechanical & electrical interlock units	VE 5-1	1SBN 030 110 R1000	1	0.076
	VE 5-2	1SBN 030 210 R1000	1	0.146
Connection sets	BER 16V	1SBN 081 411 R1000	1	0.045
	BER 40V	1SBN 082 411 R1000	1	0.085
	BEM 75-30	1SBN 083 501 R1000	1	0.243
	BEM 110-30	1SFN 084 301 R1000	1	0.450

>> Other accessories, ordering details..... page 57

>> Other contactor and thermal overload relay types Main Catalogue

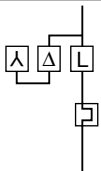

Star-Delta Starters without Interlock Unit Open Type Version, in Kit Form

Protected by Thermal Overload Relay

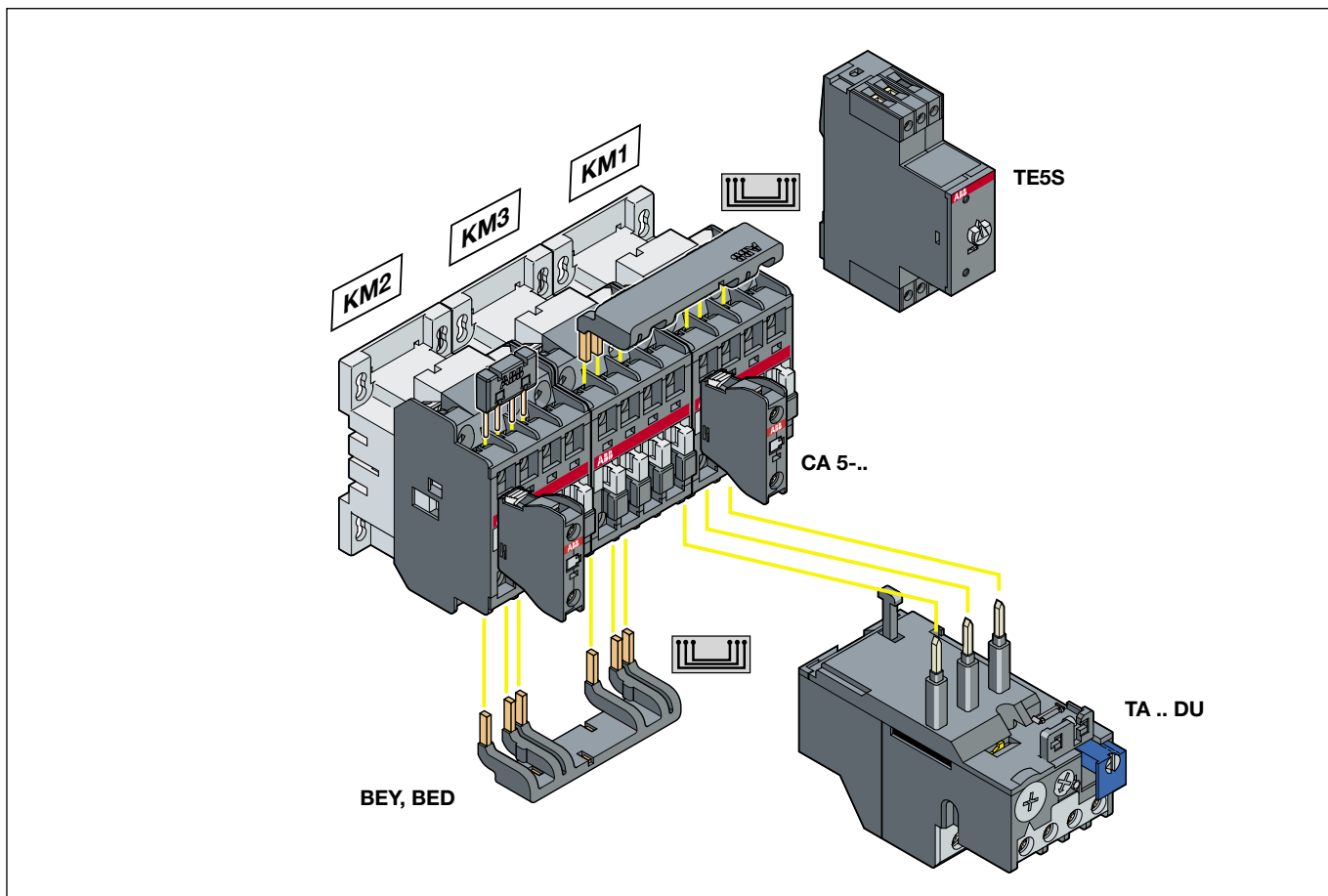

Star-Delta Starters without interlock unit - Mounting: Star KM2 - Delta KM3 - Line KM1 Contactors

3-pole a.c. operated contactors		KM2			KM3			KM1			KM2			KM3			KM1														
		A9	A9	A9	A16	A26	A26	A26	A30	A30	A30	A30	A50	A50	A50	A50	A75	A75	A75	A75	A95	A95	A95	A95	A110	A110					
		A9	A12	A12					A26	A40	A40	A40	A40	A63	A63																
		A12	A16	A16																											
Connection sets		BEY 16-1			BEY 26-1			BEY 40-1			BED 50-1			BED 75-1			BED 95			BED 110											
Additional auxiliary contact blocks		KM1			CA 5-10			2 x CA 5-10			2 x CA 5-10			KM2			CA 5-10			1 x CA 5-10 + 1 x CA 5-01			KM3			-			CA 5-01		
		TA 25 DU			0.1 ... 0.16 A to 24 ... 32 A			TA 75 DU			18 ... 25 A to 60 ... 80 A			TA 110 DU			65 ... 90 A to 80 ... 110 A			TA 42 DU			18 ... 25 A to 29 ... 42 A								
Timers		TE5S-24			or			TE5S-120			or			TE5S-240			or			TE5S-440											
Mounting plate		-			-			-			-			-			-			-			PN 110-41								

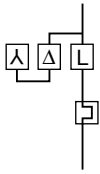

Star-Delta Starters without Interlock Unit Open Type Version, in Kit Form

Protected by Thermal Overload Relay

Application

Star-delta starters without interlock unit for controlling three-phase asynchronous motors:

- for a maximum operational voltage up to 690 V - 50 or 60 Hz
- with an ambient temperature near the devices of ≤ 55 °C
- switching frequency / hour, see page 5.

Coordination

See "Online Product Selection Tools" on "www.abb.com/lowvoltage" website. Click on "Online Selected Optimized Coordinations" to display the required coordination table according to the short-circuit protection device and the coordination type complying with IEC / EN 60947-4-1.

Mounting and Connection Accessory Description

BEY or BED connection sets allow to assemble quickly star-delta starters without interlock unit, with contactors assembled according to a star-delta-line mounting. These accessories eliminate the potential risk of wiring errors, reduce the time required to install and to maintain star-delta starters. Electrical interlocking is realized with N.C. built-in or add-on auxiliary contacts of both Star and Delta contactors.

Variants

For star-delta starters 7.5 kW up to 37 kW with contactors mounted according to a line-delta-star mounting, select BEY 16-2, BEY 26-2 and BEY 40-2 connection sets.

Star-Delta Starters - Selection and Ordering Details (for coil voltage codes and thermal overload relay ranges, see pages 0/1 and 0/2 in the cover flap)

Rated Power 400 V	Rated Power 415 V	Rated Power 690 V	Star Contactor KM2 Type state coil voltage ___ Order Code state coil voltage code □□	Delta Contactor KM3 Type state coil voltage ___ Order Code state coil voltage code □□	Line Contactor KM1 Type state coil voltage ___ Order Code state coil voltage code □□	Thermal Overload Relay (1) Type state max. setting range ___ Order Code state setting range code □□	Connection Set Type Order Code
kW	kW	kW					
7.5	7.5	5.5	A 9-30-01 ___ 1SBL 141 001 R□□01	A 9-30-01 ___ 1SBL 141 001 R□□01	A 9-30-10 ___ 1SBL 141 001 R□□10	TA 25 DU ___ 1SAZ 211 201 R10□□	BEY 16-1 1SBN 081 413 R1000
11	11	7.5	A 9-30-01 ___ 1SBL 141 001 R□□01	A 12-30-01 ___ 1SBL 161 001 R□□01	A 12-30-10 ___ 1SBL 161 001 R□□10	TA 25 DU ___ 1SAZ 211 201 R10□□	BEY 16-1 1SBN 081 413 R1000
15	15	11	A 12-30-01 ___ 1SBL 161 001 R□□01	A 16-30-01 ___ 1SBL 181 001 R□□01	A 16-30-10 ___ 1SBL 181 001 R□□10	TA 25 DU ___ 1SAZ 211 201 R10□□	BEY 16-1 1SBN 081 413 R1000
22	22	15	A 16-30-01 ___ 1SBL 181 001 R□□01	A 26-30-01 ___ 1SBL 241 001 R□□01	A 26-30-10 ___ 1SBL 241 001 R□□10	TA 25 DU ___ 1SAZ 211 201 R10□□	BEY 26-1 1SBN 082 413 R1000
25	25	18.5	A 26-30-01 ___ 1SBL 241 001 R□□01	A 30-30-01 ___ 1SBL 281 001 R□□01	A 30-30-10 ___ 1SBL 281 001 R□□10	TA 25 DU ___ 1SAZ 211 201 R10□□	BEY 40-1 1SBN 082 813 R1000
37	37	37	A 26-30-01 ___ 1SBL 241 001 R□□01	A 40-30-01 ___ 1SBL 321 001 R□□01	A 40-30-10 ___ 1SBL 321 001 R□□10	TA 42 DU ___ 1SAZ 311 201 R10□□	BEY 40-1 1SBN 082 813 R1000
45	45	45	A 30-30-01 ___ 1SBL 281 001 R□□01	A 50-30-00 ___ 1SBL 351 001 R□□00	A 50-30-00 ___ 1SBL 351 001 R□□00	TA 75 DU ___ 1SAZ 321 201 R10□□	BED 50-1 1SBN 083 503 R1001
55	55	59	A 40-30-01 ___ 1SBL 321 001 R□□01	A 63-30-00 ___ 1SBL 371 001 R□□00	A 63-30-00 ___ 1SBL 371 001 R□□00	TA 75 DU ___ 1SAZ 321 201 R10□□	BED 50-1 1SBN 083 503 R1001
63	70	63	A 50-30-00 ___ 1SBL 351 001 R□□00	A 75-30-00 ___ 1SBL 411 001 R□□00	A 75-30-00 ___ 1SBL 411 001 R□□00	TA 75 DU ___ 1SAZ 321 201 R10□□	BED 75-1 1SBN 084 103 R1001
75	75	90	A 75-30-00 ___ 1SBL 411 001 R□□00	A 95-30-00 ___ 1SFL 431 001 R□□00	A 95-30-00 ___ 1SFL 431 001 R□□00	TA 110 DU ___ 1SAZ 411 201 R10□□	BED 95 1SFN 084 303 R1000
90	100	132	A 95-30-00 ___ 1SFL 431 001 R□□00	A 110-30-00 ___ 1SFL 451 001 R□□00	A 110-30-00 ___ 1SFL 451 001 R□□00	TA 110 DU ___ 1SAZ 411 201 R10□□	BED 110 1SFN 084 503 R1000

(1) The setting current value is: nominal motor current x 0.58

Ordering Details - Main Accessories

Description	Rated control voltage U_c	Type	Order Code	Pack ^{ing} pieces	Weight kg
Auxiliary contact blocks		CA 5-10	1SBN 010 010 R1010	10	0.014
		CA 5-01	1SBN 010 010 R1001	10	0.014
Electronic timers	24 V a.c./d.c.	TE5S-24	1SBN 020 010 R1001	1	0.080
	110 ... 120 V a.c.	TE5S-120	1SBN 020 010 R1002	1	0.080
	220 ... 240 V a.c.	TE5S-240	1SBN 020 010 R1003	1	0.080
	380 ... 440 V a.c.	TE5S-440	1SBN 020 010 R1004	1	0.080
Mounting plate		PN 110-41	1SFN 094 303 R1000	1	0.950

>> Other accessories, ordering details..... page 57

>> Other contactor and thermal overload relay types Main Catalogue

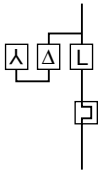

Star-Delta Starters with Interlock Unit Open Type Version, in Kit Form

Protected by Thermal Overload Relay

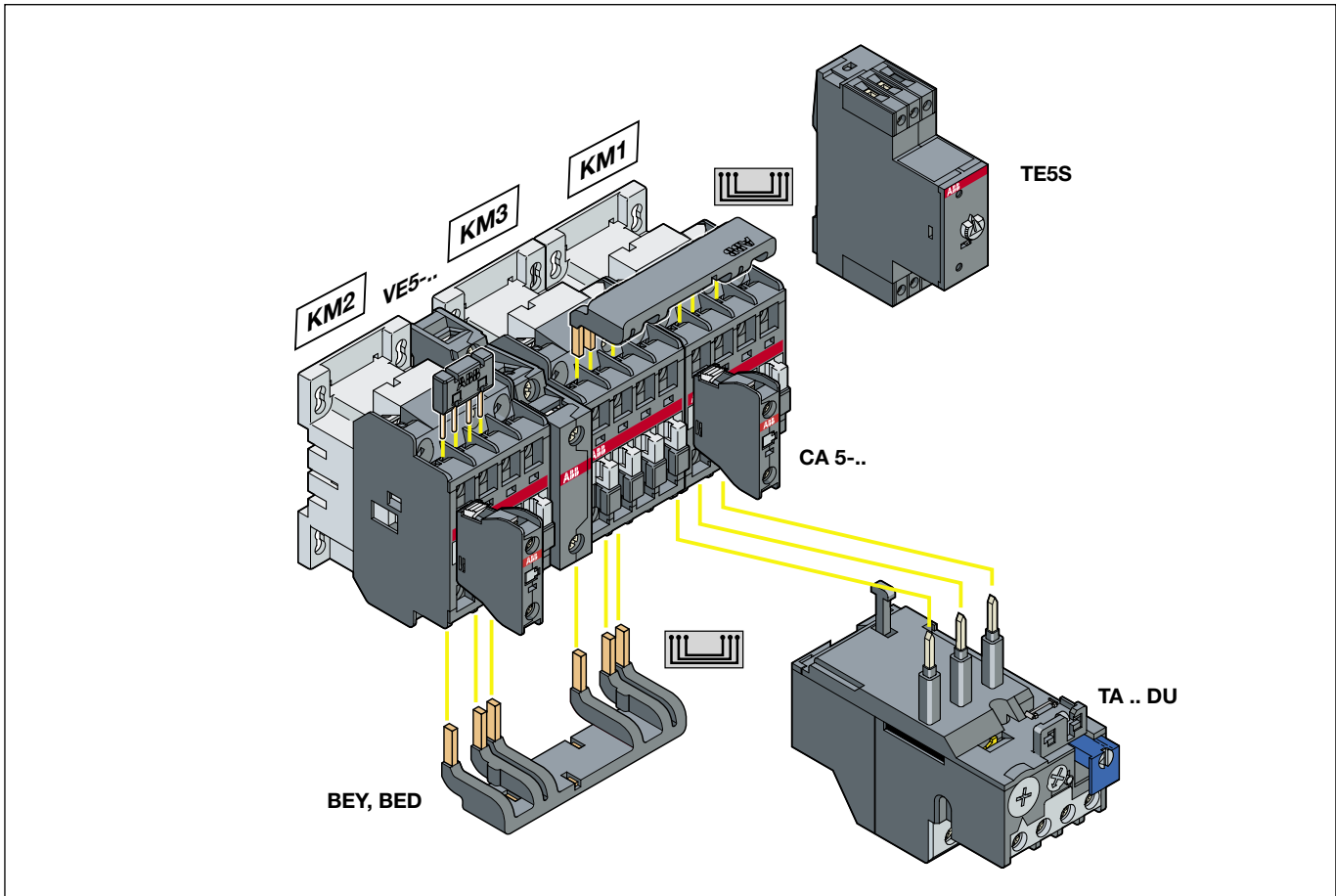

Star-Delta Starters with interlock unit - Mounting: Star KM2 - Delta KM3 - Line KM1 Contactors

		3-pole a.c. operated contactors																								
		KM2	KM3	KM1	KM2	KM3	KM1	KM2	KM3	KM1	KM2	KM3	KM1	KM2	KM3	KM1	KM2	KM3	KM1							
		A9	A9	A9	A16	A26	A26	A26	A30	A30	A30	A30	A50	A50	A50	A50	A75	A75	A75	A75	A95	A95	A95	A95	A110	A110
		A9	A12	A12				A26	A40	A40			A40	A63	A63											
		A12	A16	A16																						
Connection sets		BEY 16V-1			BEY 26-1			BEY 40-1			BED 50			BED 75			BED 95			BED 110						
Additional auxiliary contact blocks		KM1 CA 5-10									2 x CA 5-10			2 x CA 5-10												
		KM2 -									-			1 x CA 5-10												
		TA 25 DU 0.1 ... 0.16 A to 24 ... 32 A						TA 42 DU 18 ... 25 A to 29 ... 42 A			TA 75 DU 18 ... 25 A to 60 ... 80 A			TA 110 DU 65 ... 90 A to 80 ... 110 A												
Interlock units		VE 5-1						VE 5-2																		
Timers		TE5S-24			or			TE5S-120			or			TE5S-240			or			TE5S-440						
Mounting plate		-									PN 110-41															

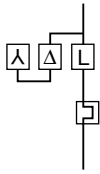

Star-Delta Starters with Interlock Unit Open Type Version, in Kit Form

Protected by Thermal Overload Relay

Application

Star-delta starters with electrical and mechanical interlock unit for controlling three-phase asynchronous motors:
 - for a maximum operational voltage up to 690 V - 50 or 60 Hz
 - with an ambient temperature near the devices of ≤ 55 °C
 - switching frequency / hour, see page 5.

Coordination

See "Online Product Selection Tools" on "www.abb.com/lowvoltage" website. Click on "Online Selected Optimized Coordinations" to display the required coordination table according to the short-circuit protection device and the coordination type complying with IEC / EN 60947-4-1.

Mounting and Connection Accessory Description

BEY or BED connection sets allow to assemble quickly star-delta starters with electrical and mechanical interlock unit, with contactors assembled according to a star-delta-line mounting. These accessories eliminate the potential risk of wiring errors, reduce the time required to install and to maintain star-delta starters. Electrical interlocking is realized with N.C. auxiliary contacts of the VE5-.. interlock unit.

Variants

For star-delta starters 7.5 kW up to 37 kW with contactors mounted according to a line-delta-star mounting, select BEY 16V-2, BEY 26-2 and BEY 40-2 connection sets.

Star-Delta Starter - Selection and Ordering Details (for coil voltage codes and thermal overload relay ranges, see pages 0/1 and 0/2 in the cover flap)

Rated Power 400 V	Rated Power 415 V	Rated Power 690 V	Star Contactor KM2 Type state coil voltage _____ Order Code state coil voltage code □□	Delta Contactor KM3 Type state coil voltage _____ Order Code state coil voltage code □□	Line Contactor KM1 Type state coil voltage _____ Order Code state coil voltage code □□	Thermal Overload Relay (1) Type state max. setting range _____ Order Code state setting range code □□	Interlock Unit Type	Connection Set Type
kW	kW	kW						
7.5	7.5	5.5	A 9-30-10 _____ 1SBL 141 001 R □□10	A 9-30-10 _____ 1SBL 141 001 R □□10	A 9-30-10 _____ 1SBL 141 001 R □□10	TA 25 DU _____ 1SAZ 211 201 R10 □□	VE 5-1	BEY 16V-1
11	11	7.5	A 9-30-10 _____ 1SBL 141 001 R □□10	A 12-30-10 _____ 1SBL 161 001 R □□10	A 12-30-10 _____ 1SBL 161 001 R □□10	TA 25 DU _____ 1SAZ 211 201 R10 □□	VE 5-1	BEY 16V-1
15	15	11	A 12-30-10 _____ 1SBL 161 001 R □□10	A 16-30-10 _____ 1SBL 181 001 R □□10	A 16-30-10 _____ 1SBL 181 001 R □□10	TA 25 DU _____ 1SAZ 211 201 R10 □□	VE 5-1	BEY 16V-1
22	22	15	A 16-30-10 _____ 1SBL 181 001 R □□10	A 26-30-10 _____ 1SBL 241 001 R □□10	A 26-30-10 _____ 1SBL 241 001 R □□10	TA 25 DU _____ 1SAZ 211 201 R10 □□	VE 5-1	BEY 26-1
25	25	18.5	A 26-30-10 _____ 1SBL 241 001 R □□10	A 30-30-10 _____ 1SBL 281 001 R □□10	A 30-30-10 _____ 1SBL 281 001 R □□10	TA 25 DU _____ 1SAZ 211 201 R10 □□	VE 5-1	BEY 40-1
37	37	37	A 26-30-10 _____ 1SBL 241 001 R □□10	A 40-30-10 _____ 1SBL 321 001 R □□10	A 40-30-10 _____ 1SBL 321 001 R □□10	TA 42 DU _____ 1SAZ 311 201 R10 □□	VE 5-1	BEY 40-1
45	45	45	A 30-30-10 _____ 1SBL 281 001 R □□10	A 50-30-00 _____ 1SBL 351 001 R □□00	A 50-30-00 _____ 1SBL 351 001 R □□00	TA 75 DU _____ 1SAZ 321 201 R10 □□	VE 5-2	BED 50
55	55	59	A 40-30-10 _____ 1SBL 321 001 R □□10	A 63-30-00 _____ 1SBL 371 001 R □□00	A 63-30-00 _____ 1SBL 371 001 R □□00	TA 75 DU _____ 1SAZ 321 201 R10 □□	VE 5-2	BED 50
63	70	63	A 50-30-00 _____ 1SBL 351 001 R □□00	A 75-30-00 _____ 1SBL 411 001 R □□00	A 75-30-00 _____ 1SBL 411 001 R □□00	TA 75 DU _____ 1SAZ 321 201 R10 □□	VE 5-2	BED 75
75	75	90	A 75-30-00 _____ 1SBL 411 001 R □□00	A 95-30-00 _____ 1SFL 431 001 R □□00	A 95-30-00 _____ 1SFL 431 001 R □□00	TA 110 DU _____ 1SAZ 411 201 R10 □□	VE 5-2	BED 95
90	100	132	A 95-30-00 _____ 1SFL 431 001 R □□00	A 110-30-00 _____ 1SFL 451 001 R □□00	A 110-30-00 _____ 1SFL 451 001 R □□00	TA 110 DU _____ 1SAZ 411 201 R10 □□	VE 5-2	BED 110

(1) The setting current value is: nominal motor current x 0.58

Ordering Details - Main Accessories

Description	Rated control voltage U _c	Type	Order Code	Pack ^{ing} pieces	Weight kg
Connection sets		BEY 16V-1	1SBN 081 413 R1001	1	0.045
		BEY 26-1	1SBN 082 413 R1000	1	0.060
		BEY 40-1	1SBN 082 813 R1000	1	0.060
		BED 50	1SBN 083 503 R1000	1	0.280
		BED 75	1SBN 084 103 R1000	1	0.250
		BED 95	1SFN 084 303 R1000	1	0.400
		BED 110	1SFN 084 503 R1000	1	0.500
Auxiliary contact blocks		CA 5-10	1SBN 010 010 R1010	10	0.014
		CA 5-01	1SBN 010 010 R1001	10	0.014
Interlock units		VE 5-1	1SBN 030 110 R1000	1	0.076
		VE 5-2	1SBN 030 210 R1000	1	0.146
Electronic timers	24 V a.c./d.c.	TE5S-24	1SBN 020 010 R1001	1	0.080
	110 ... 120 V a.c.	TE5S-120	1SBN 020 010 R1002	1	0.080
	220 ... 240 V a.c.	TE5S-240	1SBN 020 010 R1003	1	0.080
	380 ... 440 V a.c.	TE5S-440	1SBN 020 010 R1004	1	0.080
Mounting plate		PN 110-41	1SFN 094 303 R1000	1	0.950



Direct-On-Line Starters Open Type Version in Kit Form

Protection by Thermal Overload Relay

Wiring Diagrams for Direct-On-Line Starters

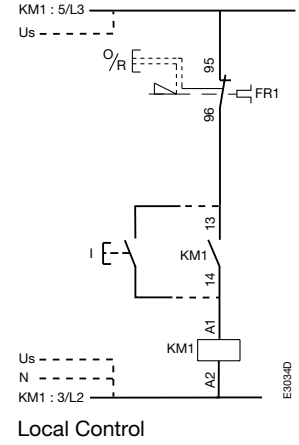
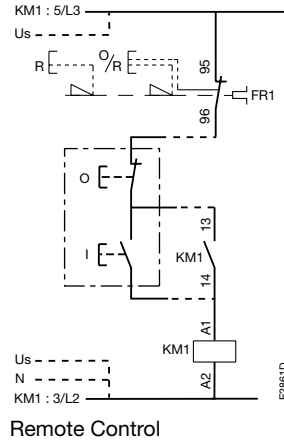
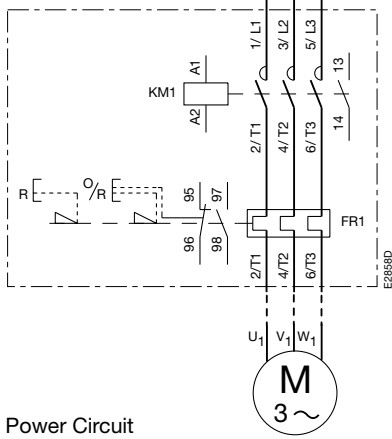

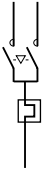

Reversing Starters

Open Type Version in Kit Form

Protection by Thermal Overload Relay

Wiring Diagram for Reversing Starters

With or without VM 5-1 mechanical interlock unit, electrical interlocking by built-in or add-on auxiliary contacts.

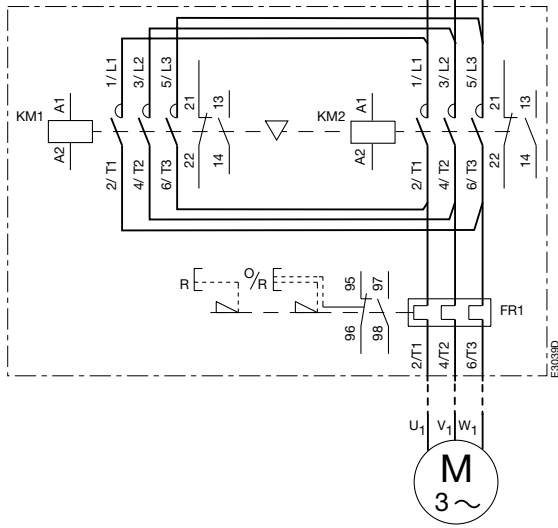

Power Circuit

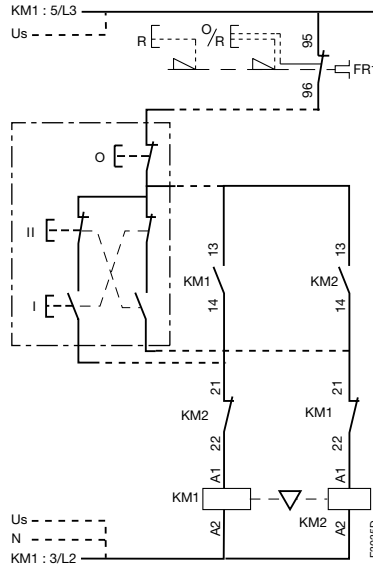

Remote Control

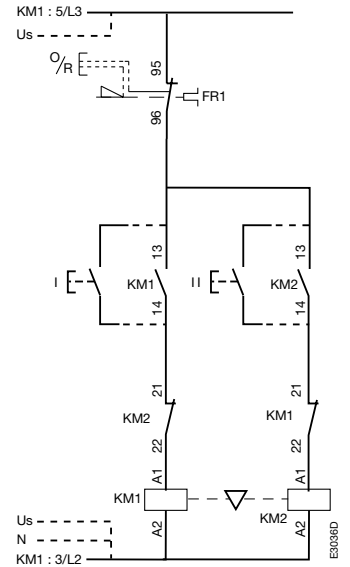

Local Control

Wiring Diagram for Reversing Starters

With VE 5-... mechanical and electrical interlock unit.

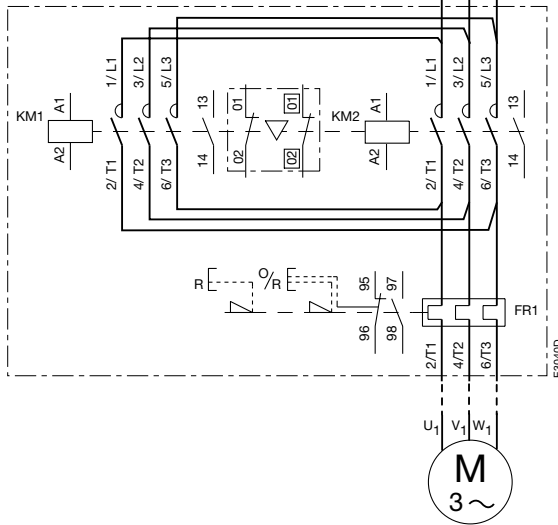

Power Circuit

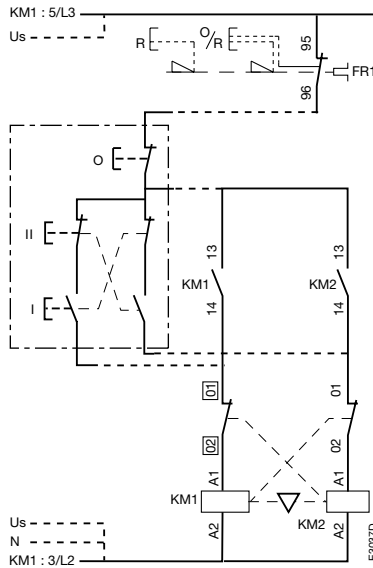

Remote Control

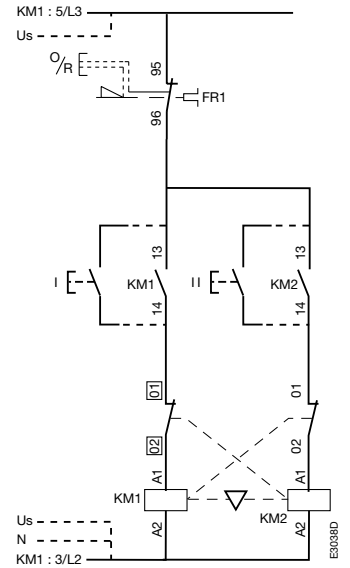

Local Control

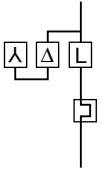

Star-Delta Starters Open Type Version in Kit Form

Protection by Thermal Overload Relay
 Star KM2 - Delta KM3 - Line KM1 Mounting

Wiring Diagram - Star-Delta Starters 7.5 ... 90 kW - 400 V AC-3

Star-Delta starters with interlock unit

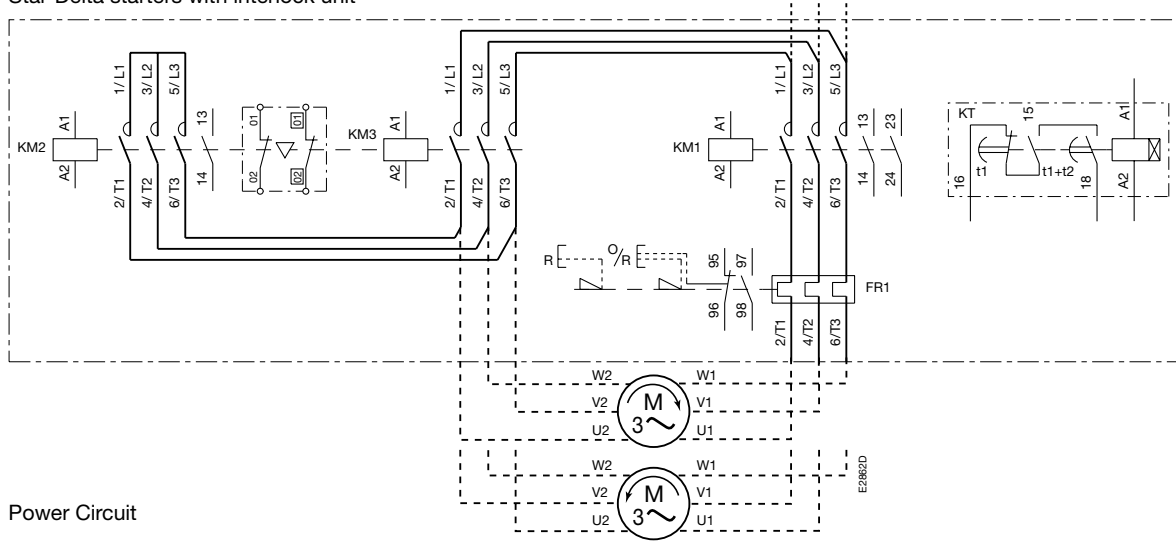

Power Circuit

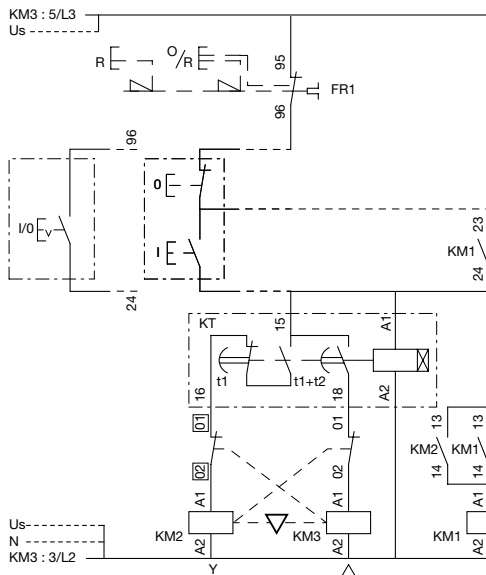

Remote Control

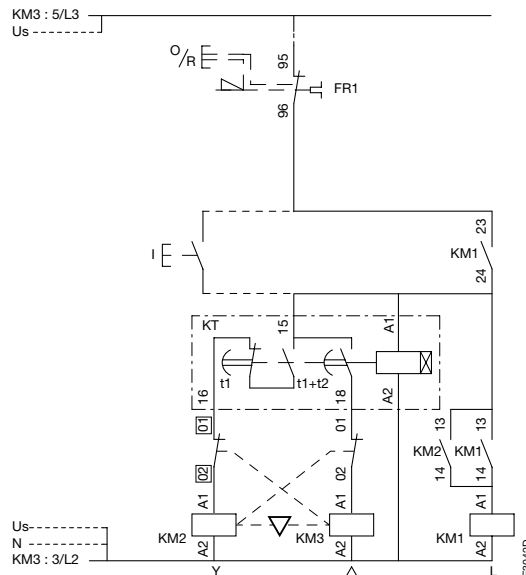

Local Control

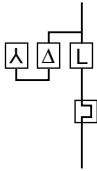

Star-Delta Starters Open Type Version in Kit Form

Protection by Thermal Overload Relay
 Star KM2 - Delta KM3 - Line KM1 Mounting

Wiring Diagram - Star-Delta Starters 7.5 ... 90 kW - 400 V AC-3
 Star-Delta starters without interlock unit

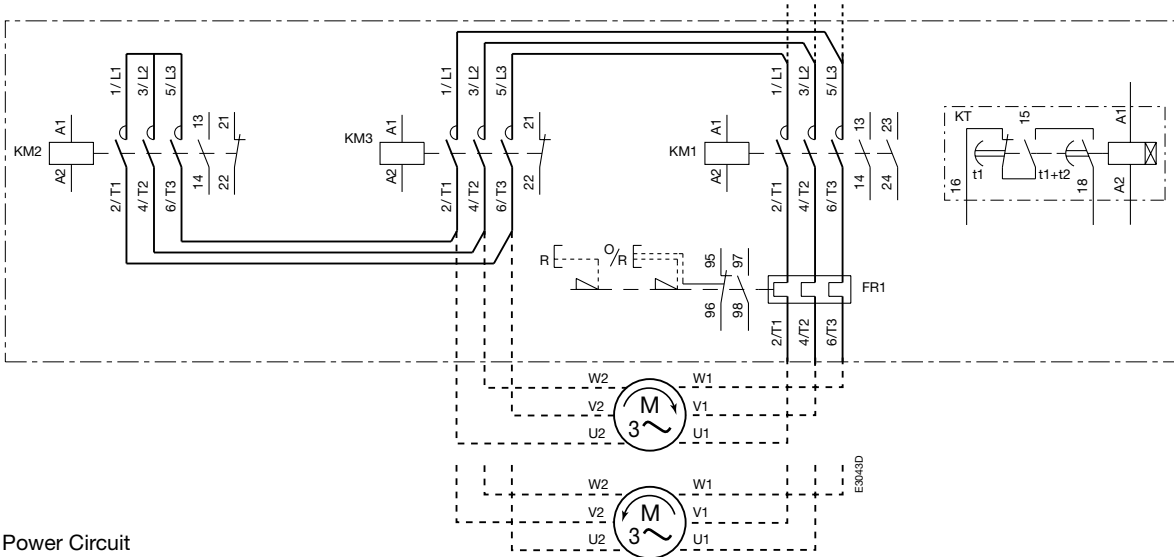

Power Circuit

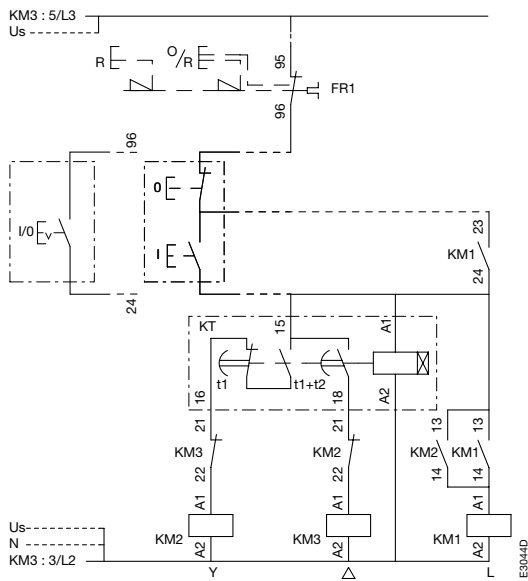

Remote Control

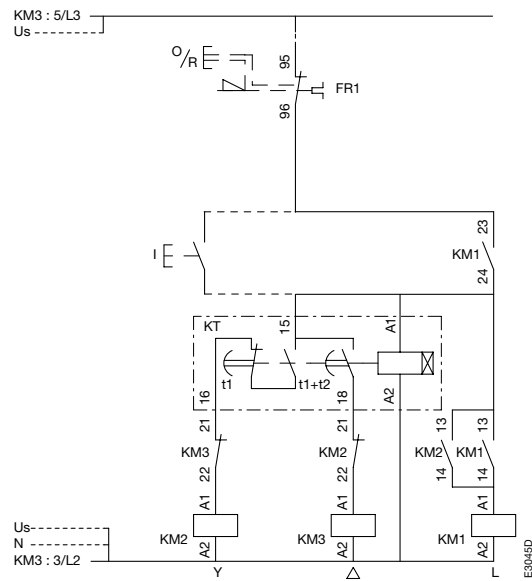

Local Control

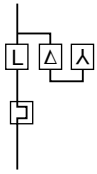

Star-Delta Starters Open Type Version in Kit Form

Protection by Thermal Overload Relay
 Line KM1 - Delta KM3 - Star KM2 Mounting

Wiring Diagram - Star-Delta Starters 7.5 ... 37 kW - 400 V AC-3

Star-Delta starters with interlock unit

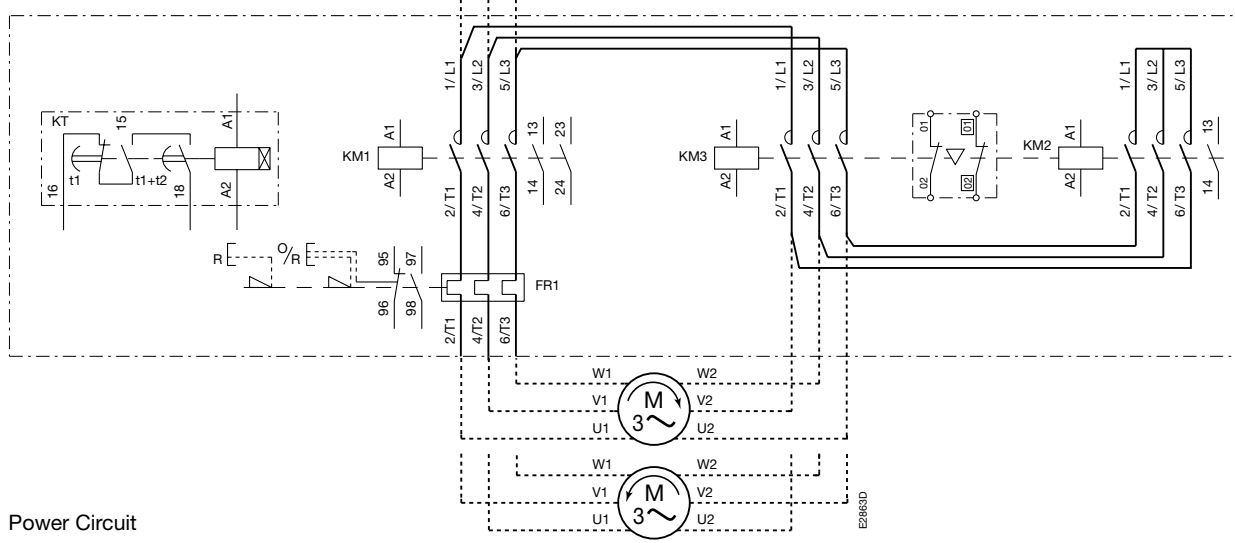

Power Circuit

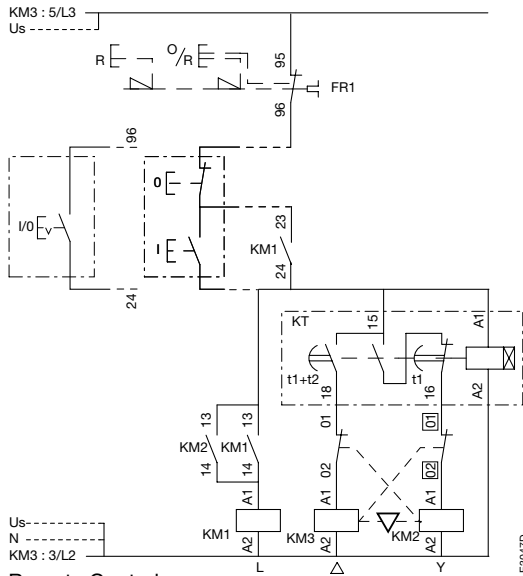

Remote Control

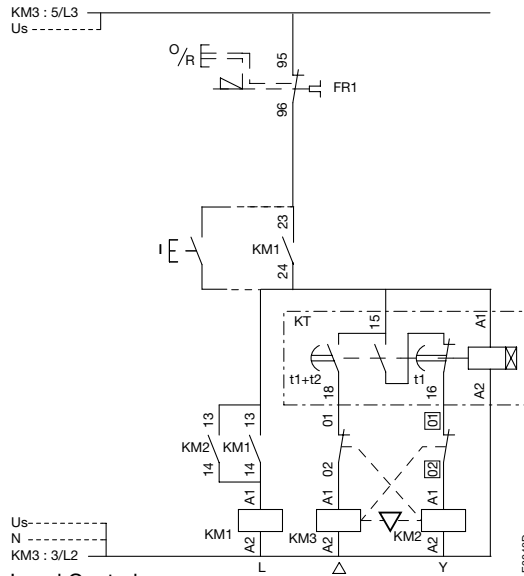

Local Control

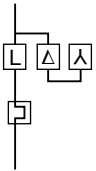

Star-Delta Starters Open Type Version in Kit Form

Protection by Thermal Overload Relay
 Line KM1 - Delta KM3 - Star KM2 Mounting

Wiring Diagram - Star-Delta Starters 7.5 ... 37 kW - 400 V AC-3
 Star-Delta starters without interlock unit

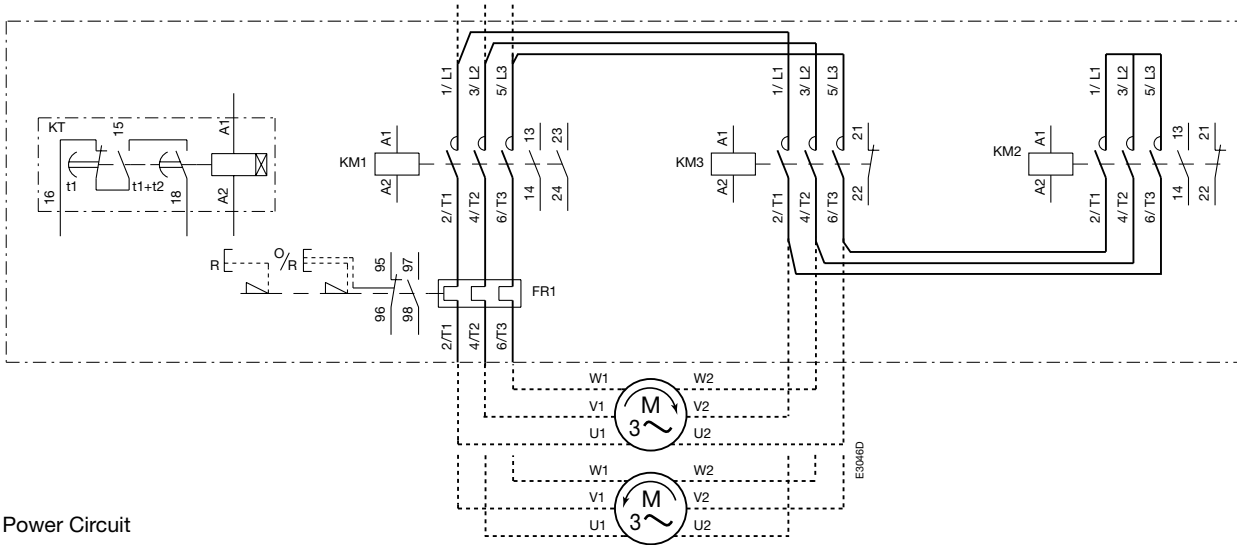

Power Circuit

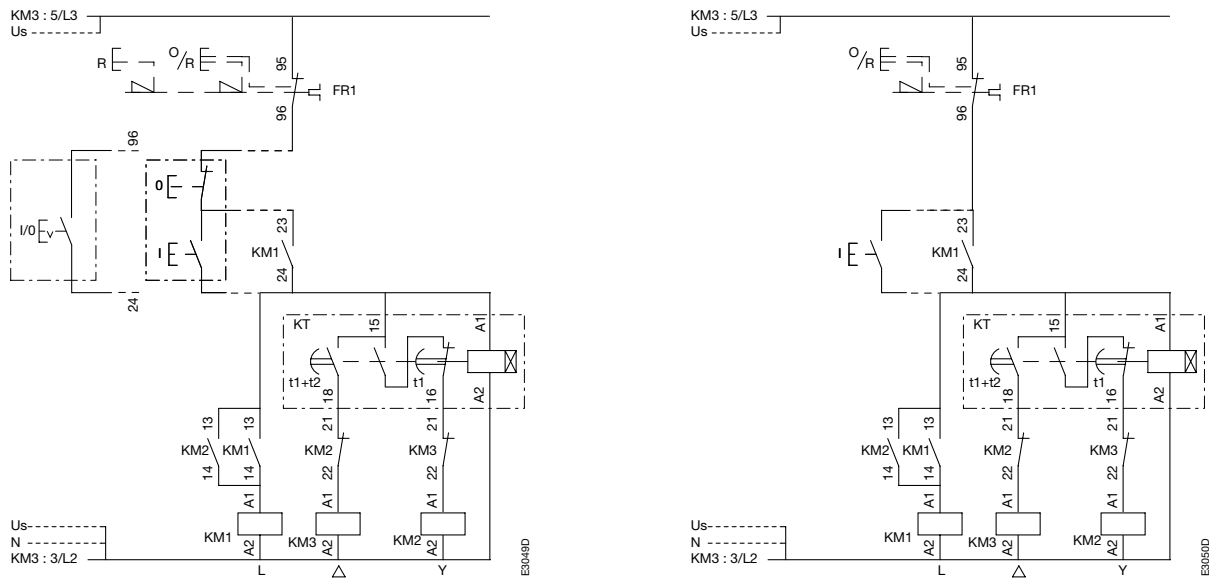

Remote Control

Local Control

A 9 ... A 16 3-pole Contactors Protected by Thermal Overload Relay

Direct-On-Line and Reversing Starters

Dimensions (in mm)

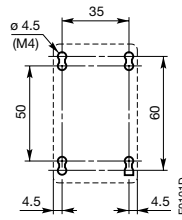
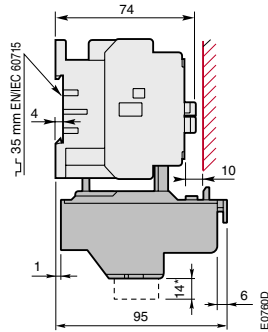
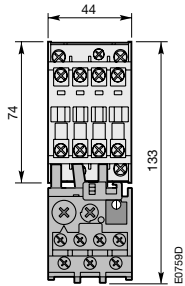

A 9, A 12, A 16
+ TA 25 DU thermal O/L relay

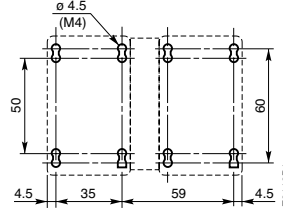
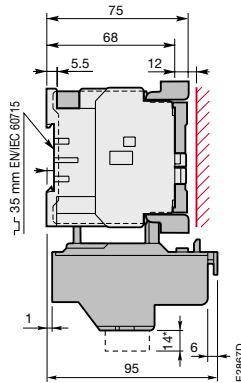
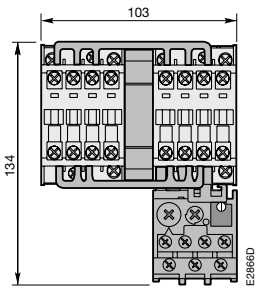

A 9, A 12, A 16
+ VM 5-1/VE 5-1 interlock unit
+ BER 16V connection set
+ TA 25 DU thermal O/L relay

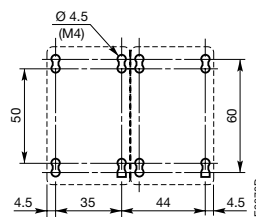
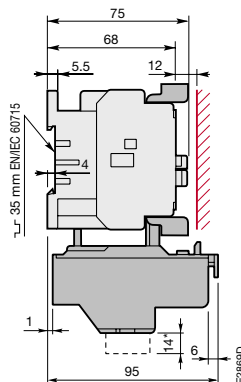
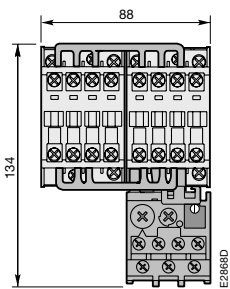

A 9, A 12, A 16
+ BER 16 connection set
+ TA 25 DU thermal O/L relay

* For TA 25 DU 32 only

A 26 3-pole Contactor Protected by Thermal Overload Relay

Direct-On-Line and Reversing Starters

Dimensions (in mm)

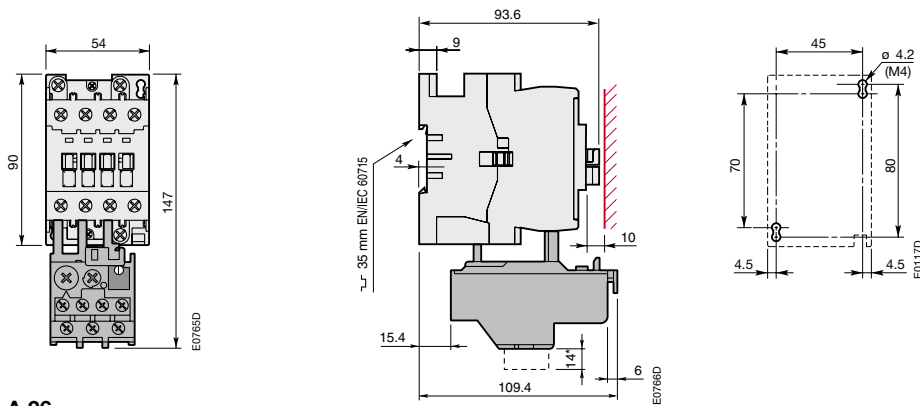

A 26
+ TA 25 DU thermal O/L relay

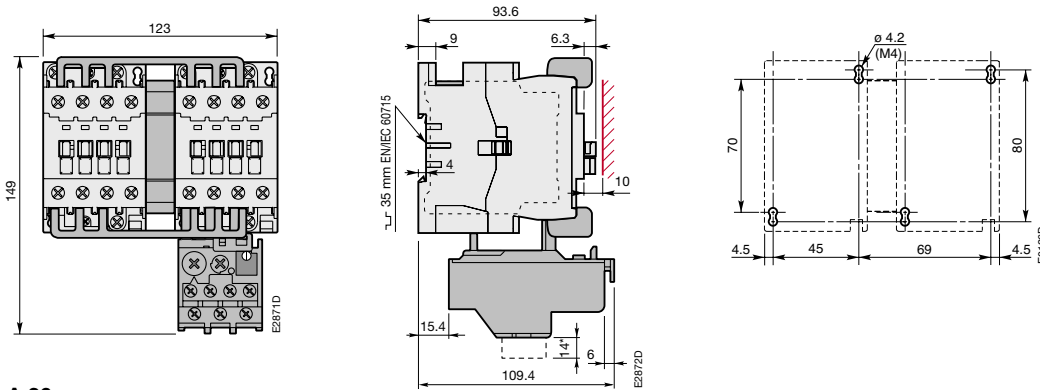

A 26
+ VM 5-1/VE 5-1 interlock unit
+ BER 40V connection set
+ TA 25 DU thermal O/L relay

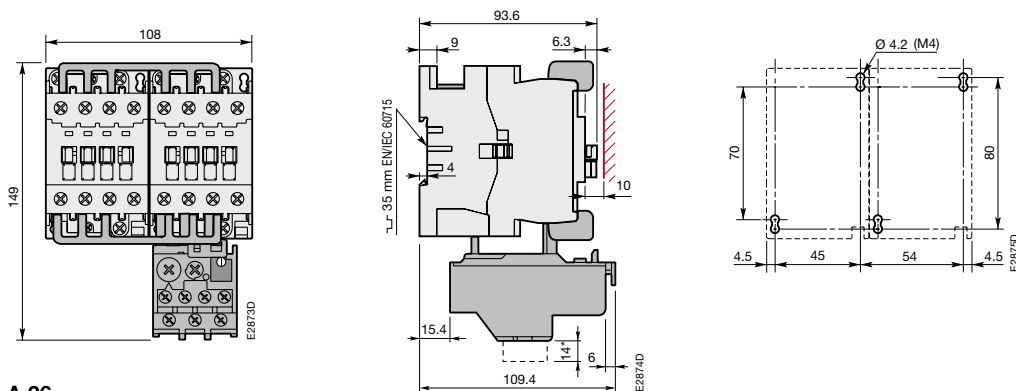

A 26
+ BER 40 connection set
+ TA 25 DU thermal O/L relay

* For TA 25 DU 32 only

A 30 and A 40 3-pole Contactors Protected by Thermal Overload Relay

Direct-On-Line and Reversing Starters

Dimensions (in mm)

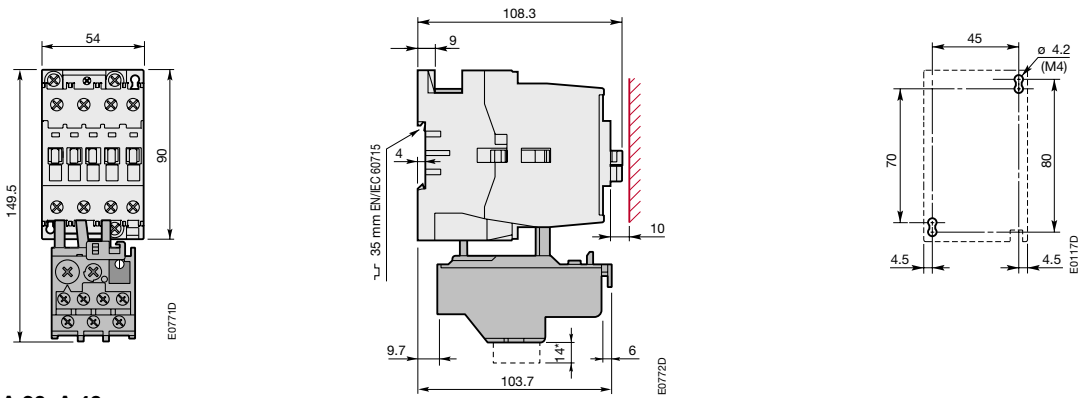

A 30, A 40
+ TA 25 DU thermal O/L relay

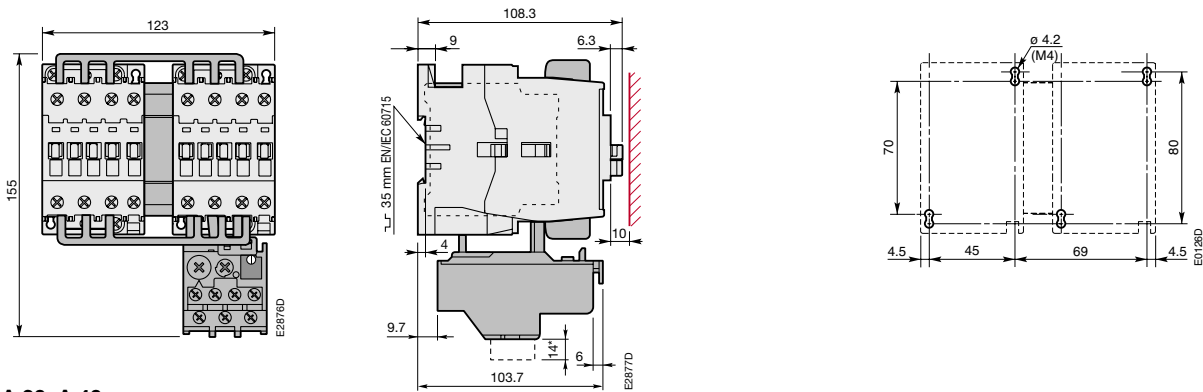

A 30, A 40
+ VM 5-1/VE 5-1 interlock unit
+ BER 40V connection set
+ TA 25 DU thermal O/L relay

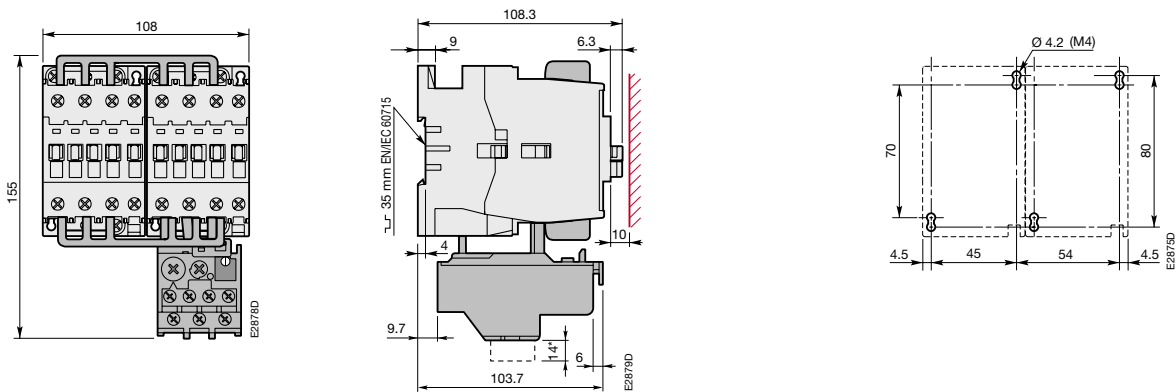

A 30, A 40
+ BER 40 connection set
+ TA 25 DU thermal O/L relay

* For TA 25 DU 32 only

A 30 and A 40 3-pole Contactors Protected by Thermal Overload Relay

Direct-On-Line and Reversing Starters

Dimensions (in mm)

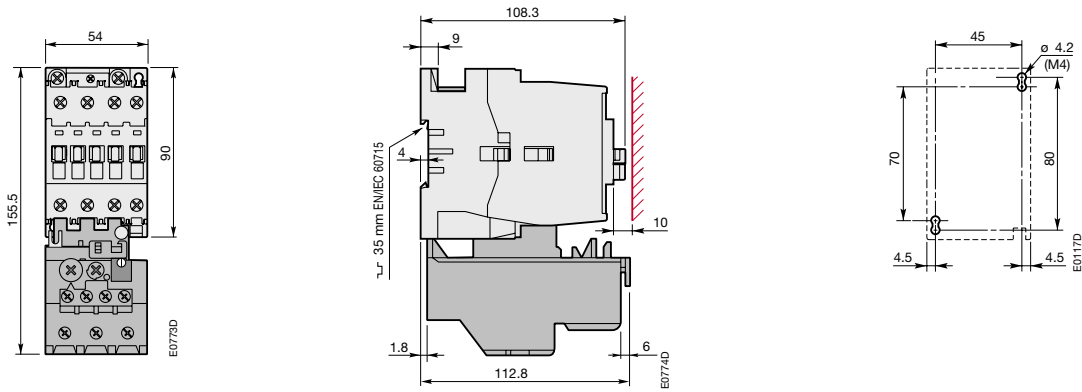

A 30, A 40
+ TA 42 DU thermal O/L relay

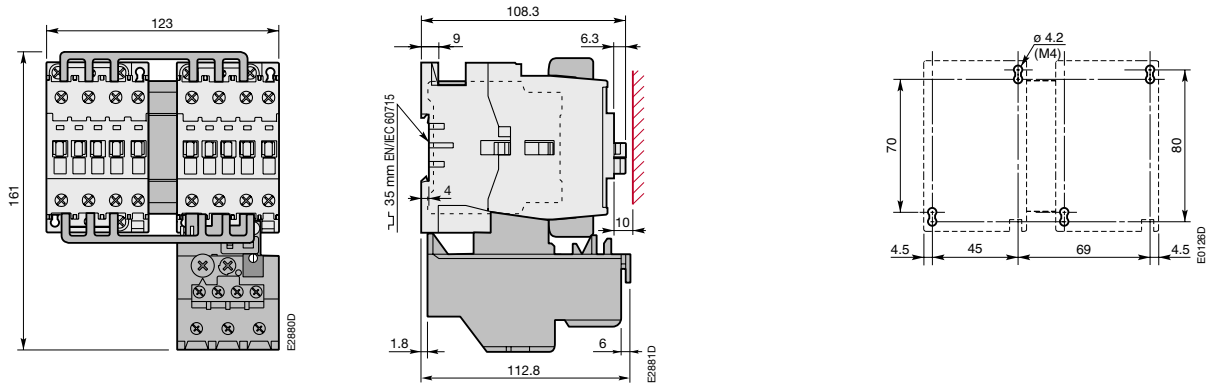

A 30, A 40
+ VM 5-1/VE 5-1 interlock unit
+ BER 40V connection set
+ TA 42 DU thermal O/L relay



A 30, A 40
+ BER 40 connection set
+ TA 42 DU thermal O/L relay

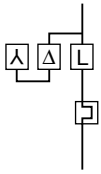

Star-Delta Starters Protected by Thermal Overload Relay

Star Delta Line Mounting

Dimensions (in mm)

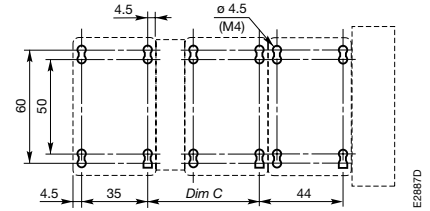
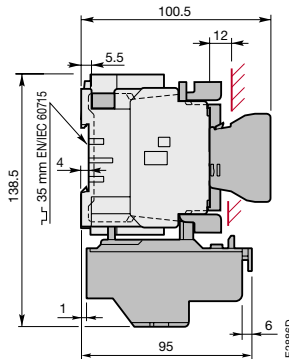
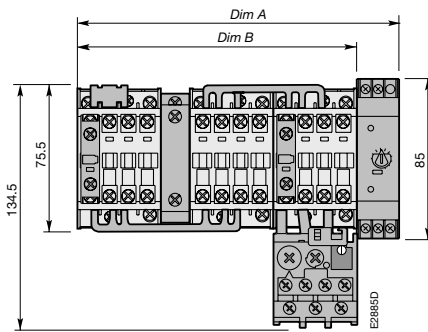

	BEY 16-1	BEY 16V-1 + VE 5-1
Dim A	155	170
Dim B	132	147
Dim C	44	59

Star KM2, Delta KM3, Line KM1 mounting type: A9 - A9 - A9, A9 - A12 - A12, A12 - A16 - A16
with or without VE 5-1 interlock unit + BEY 16.-1 connection set + TA 25 DU thermal O/L relay + TE5S electronic Timer

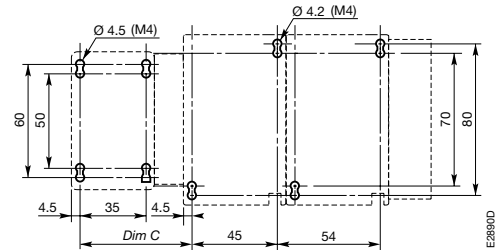
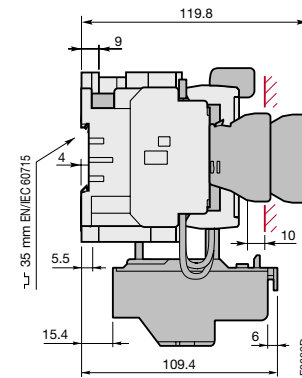
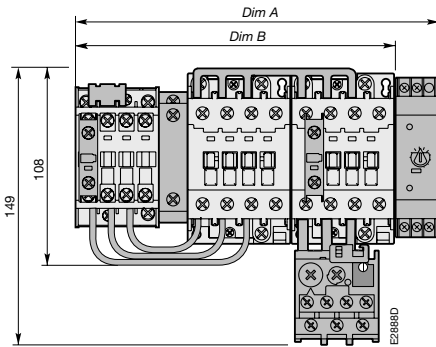

	BEY 26-1	BEY 26-1 + VE 5-1
Dim A	175	190
Dim B	152	167
Dim C	44	59

Star KM2, Delta KM3, Line KM1 mounting type: A16 - A26 - A26
with or without VE 5-1 interlock unit + BEY 26-1 connection set + TA 25 DU thermal O/L relay + TE5S electronic timer

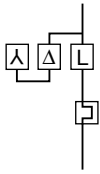

Star-Delta Starters Protected by Thermal Overload Relay Star Delta Line Mounting

Dimensions (in mm)

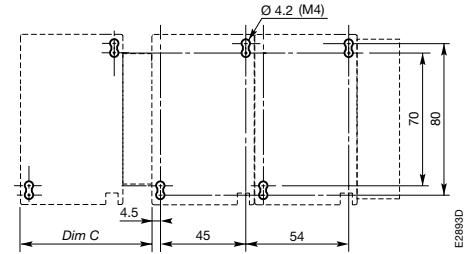
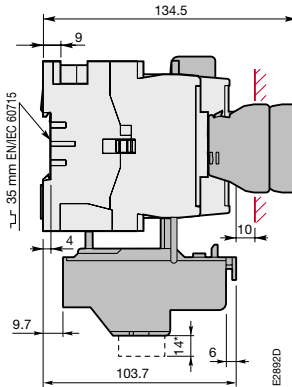
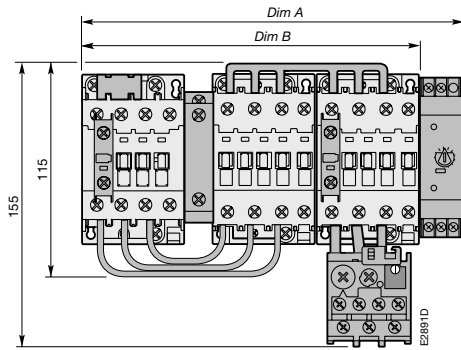

	BEY 40-1	BEY 40-1 + VE 5-1
Dim A	185	200
Dim B	162	177
Dim C	54	69

Star KM2, Delta KM3, Line KM1 mounting type: A26 - A30 - A30
with or without VE 5-1 interlock unit + BEY 40-1 connection set + TA 25 DU thermal O/L relay + TE5S electronic timer

* For TA 25 DU 32 only.

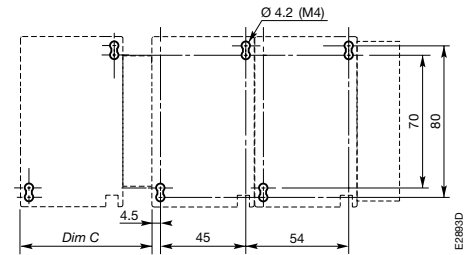
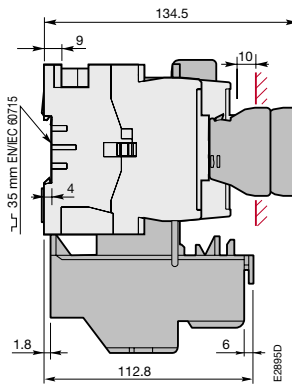
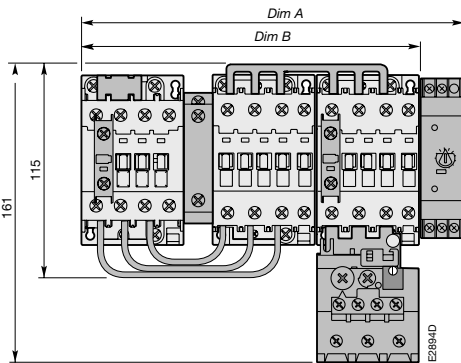

	BEY 40-1	BEY 40-1 + VE 5-1
Dim A	185	200
Dim B	162	177
Dim C	54	69

Star KM2, Delta KM3, Line KM1 mounting type: A26 - A40 - A40
with or without VE 5-1 interlock unit + BEY 40-1 connection set + TA 42 DU thermal O/L relay + TE5S electronic timer

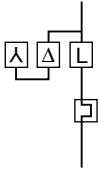

Star-Delta Starters Protected by Thermal Overload Relay

Star Delta Line Mounting

Dimensions (in mm)

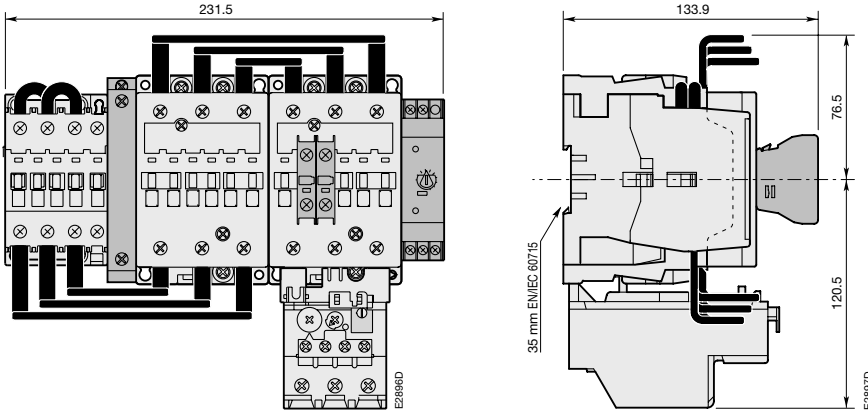

Star KM2, Delta KM3, Line KM1 mounting type: A30 - A50 - A50, A40 - A63 - A63
+ VE 5-2 interlock unit + BED 50 connection set + TA 75 DU thermal O/L relay + TE5S electronic timer

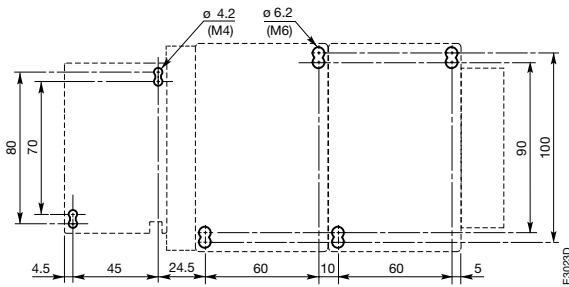

Star KM2, Delta KM3, Line KM1 mounting type: A30 - A50 - A50, A40 - A63 - A63
Drilling plan

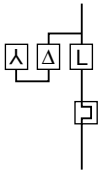

Star-Delta Starters Protected by Thermal Overload Relay

Star Delta Line Mounting

Dimensions (in mm)

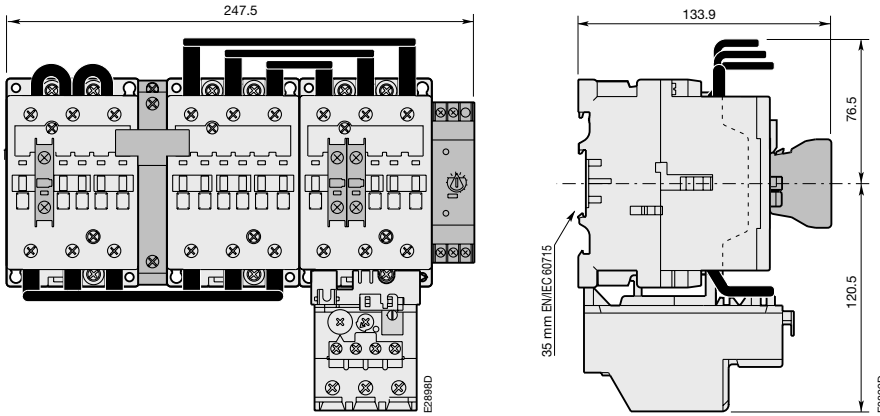

Star KM2, Delta KM3, Line KM1 mounting type: A50 - A75 - A75
+ VE 5-2 interlock unit + BED 75 connection set + TA 75 DU thermal O/L relay + TE5S electronic timer

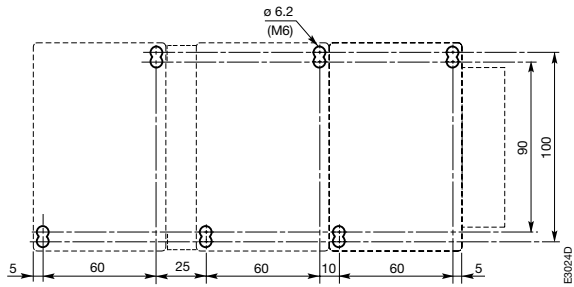

Star KM2, Delta KM3, Line KM1 mounting type: A50 - A75 - A75
Drilling plan

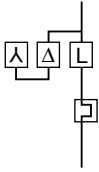

Star-Delta Starters Protected by Thermal Overload Relay

Star Delta Line Mounting

Dimensions (in mm)

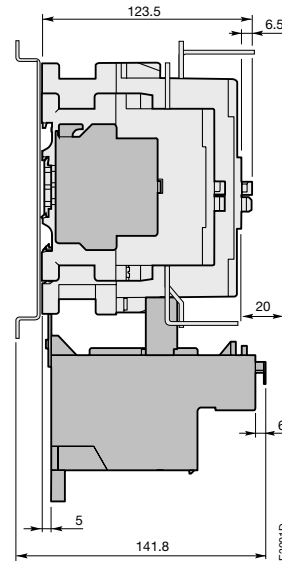
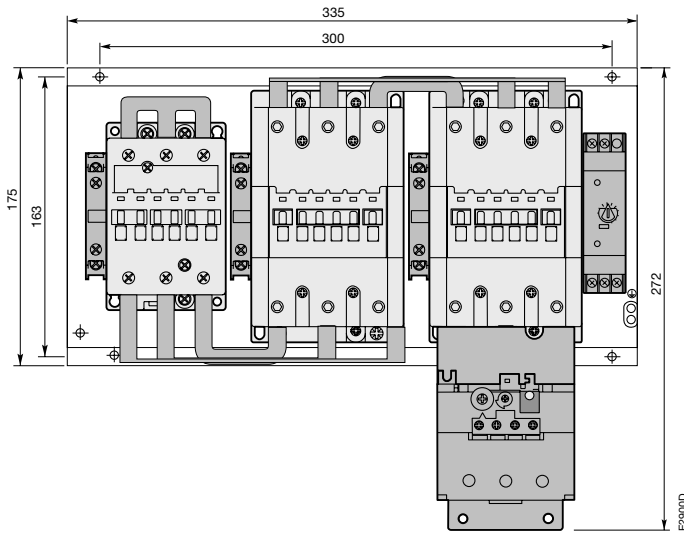

Star KM2, Delta KM3, Line KM1 mounting type: A75 - A95 - A95
without VE5-2 interlock unit + BED 95 connection set + TA 110 DU thermal O/L relay + TE5S electronic timer

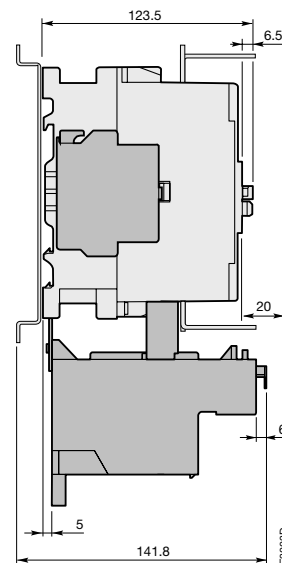
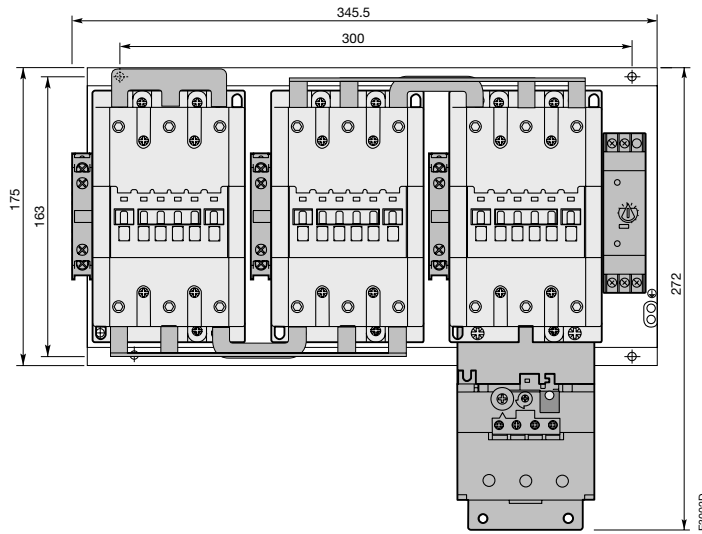

Star KM2, Delta KM3, Line KM1 mounting type: A95 - A110 - A110
without VE5-2 interlock unit + BED 110 connection set + TA 110 DU thermal O/L relay + TE5S electronic timer

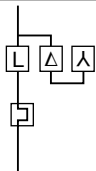

Star-Delta Starters Protected by Thermal Overload Relay

Line Delta Star Mounting

Dimensions (in mm)

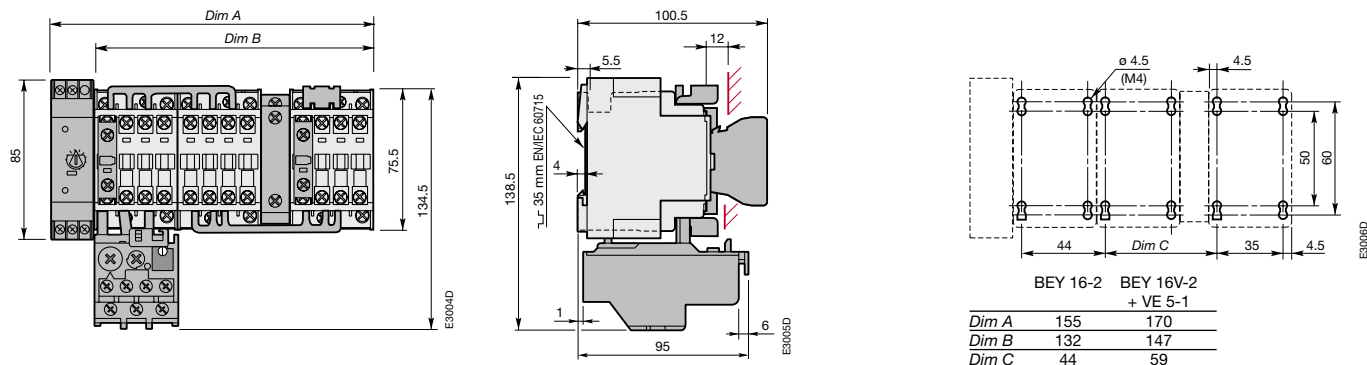

Line KM1, Delta KM3, Star KM2 mounting type: A9 - A9 - A9, A12 - A12 - A9, A16 - A16 - A12
with or without VE 5-1 interlock unit + BEY 16..-2 connection set + TA 25 DU thermal O/L relay + TE5S electronic timer

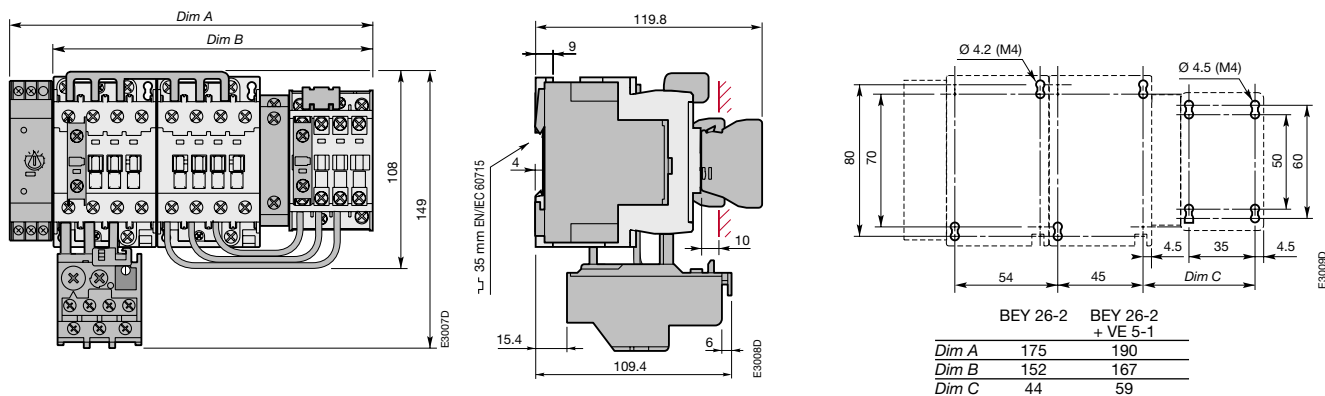

Line KM1, Delta KM3, Star KM2 mounting type: A26 - A26 - A16
with or without VE 5-1 interlock unit + BEY 26-2 connection set + TA 25 DU thermal O/L relay + TE5S electronic timer

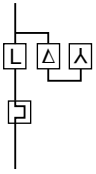

Star-Delta Starters Protected by Thermal Overload Relay

Line Delta Star Mounting

Dimensions (in mm)

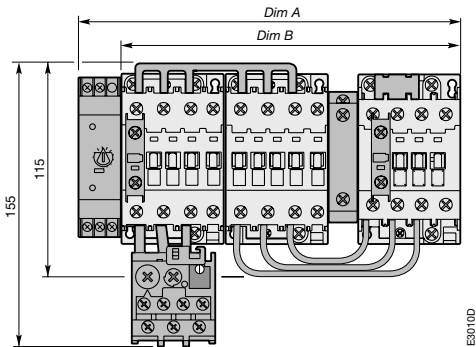

E3010D

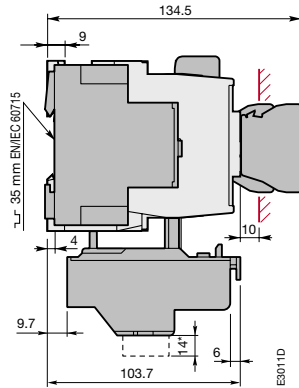

E3011D

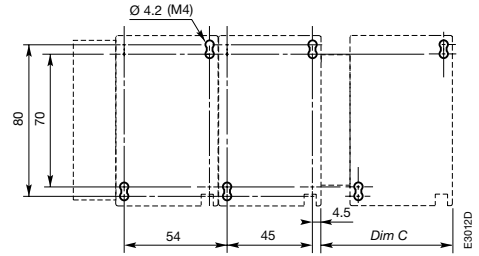

E3012D

	BEY 40-2	BEY 40-2 + VE 5-1
Dim A	185	200
Dim B	162	177
Dim C	54	69

Line KM1, Delta KM3, Star KM2 mounting type: A30 - A30 - A26

with or without VE 5-1 interlock unit + BEY 40-2 connection set + TA 25 DU thermal O/L relay + TE5S electronic timer

* TA 25 DU 32 only

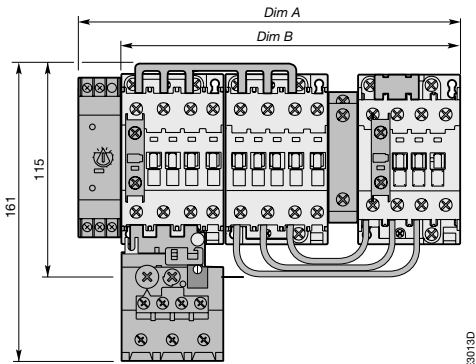

E3013D

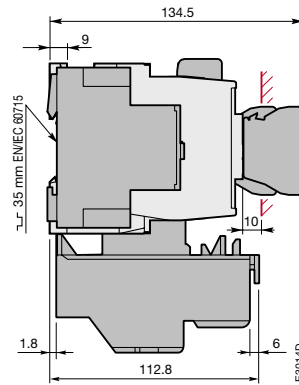

E3014D

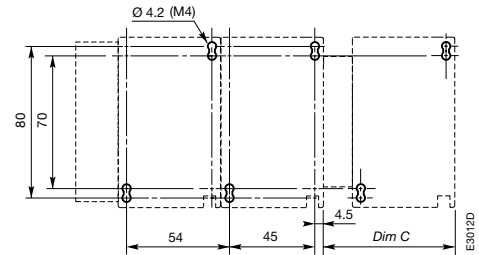

E3012D

	BEY 40-2	BEY 40-2 + VE 5-1
Dim A	185	200
Dim B	162	177
Dim C	54	69

Line KM1, Delta KM3, Star KM2 mounting type: A40 - A40 - A26

with or without VE 5-1 interlock unit + BEY 40-2 connection set + TA 42 DU thermal O/L relay + TE5S electronic timer

Main Accessories

Ordering Details

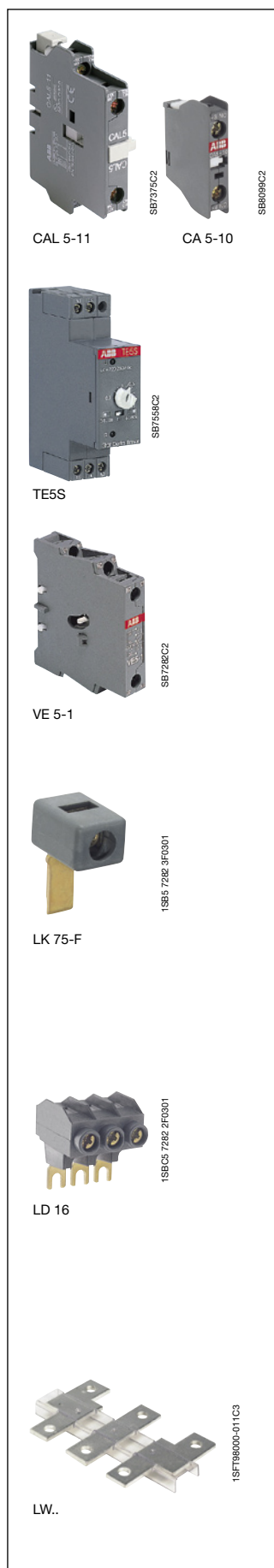

Auxiliary Contact Blocks

Positioning	Mounting on :	Contacts	Type	Order code	Pack ^{ing}	Weight
					piece	kg
Front mounting	A 9...A 110	1 -	CA 5-10	1SBN 010 010 R1010	10	0.014
		- 1	CA 5-01	1SBN 010 010 R1001	10	0.014
Side mounting	A 9...A 75	1 1	CAL 5-11	1SBN 010 020 R1011	2	0.050
	A 95...A 110	1 1	CAL 18-11	1SFN 010 720 R1011	2	0.050

Electronic Timers for star-delta starters (dwelling time 50 ms)

Mounting	Timing range	Supply voltage	Type	Order code	Pack ^{ing}	Weight
					piece	kg
Independent	Direct 0.8...8 s or 6...60 s	24 a.c. / d.c.	TE5S-24	1SBN 020 010 R1001	1	0.080
		110 ... 120 a.c.	TE5S-120	1SBN 020 010 R1002	1	0.080
		220 ... 240 a.c.	TE5S-240	1SBN 020 010 R1003	1	0.080
		380 ... 440 a.c.	TE5S-440	1SBN 020 010 R1004	1	0.080

Interlock Units for two horizontal mounted contactors

Feature	For contactor combination:	Contacts	Type	Order code	Pack ^{ing}	Weight
					piece	kg
Mech. / elec.	A 9...A 40 A 9...A 40	- 2	VE 5-1	1SBN 030 110 R1000	1	0.076
	A 30...A 40 A 50...A 75	- 2	VE 5-2	1SBN 030 210 R1000	1	0.146
	A 50...A 110 A 50...A 110					
Mechanical	A 9...A 40 A 9...A 40	- -	VM 5-1	1SBN 030 100 R1000	1	0.066

LK.. Terminals for control lead connections

Connection	Type	Order code	Pack ^{ing}	Weight
			pieces	kg
Right and left on A 45 ... A 75	LK 75-L	1SBN 073 552 R1003	2	0.006
Opposite on A 45 ... A 75	LK 75-F	1SBN 073 552 R1002	2	0.006
Right and left on A 95 ... A 110	LK 110	1SFN 074 352 R1000	2	0.010

LD.. Additional Terminal Blocks

For contactors	Type	Order code	Pack ^{ing}	Weight
			pieces	kg
A 9 ... A 16	LD 16	1SBN 071 408 R1000	2	0.030
A 26	LD 26	1SBN 072 408 R1000	2	0.040
A 30 ... A 40	LD 40	1SBN 072 808 R1000	1	0.075
A 45 ... A 75	LD 75	1SBN 073 508 R1000	1	0.115
A 95 ... A 110	LD 110	1SFN 074 308 R1000	1	0.150

Note: BEY, BED, BER and BEM connection sets can no longer be used with LD.. additional terminal blocks

LW.. Enlargement Pieces

For contactors	Dimensions		Type	Order code	Pack ^{ing}	Weight
	hole Ø	bar			set	kg
A 95, A 110	6.5	15 x 3	LW 110	1SFN 074 307 R1000	1	0.100

For other accessories, see the main catalogue.

Connecting Links, Connection Sets and Mounting Plates For Direct-On-Line and Reversing Starters

Ordering Details

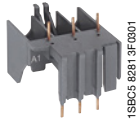

BEA 16/116



BEA 40/450

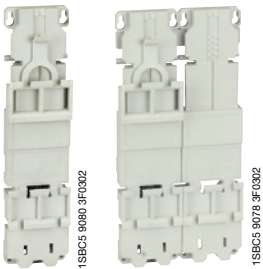

PM 26-13

PM 26-23

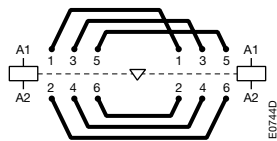

BER and BEM connection sets

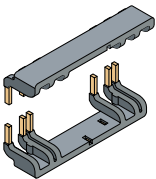

BER 16V

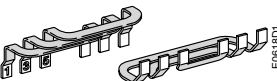

BEM 75-30

Connecting links

For contactors	For manual motor starter	Type	Order code	Pack ^{ing} piece	Weight kg 1 piece
A 9, A 12, A 16	MS 116	BEA 16/116	1SBN 081 406 R1000	10	0.020
A 26	MS 116	BEA 26/116	1SBN 082 406 R1000	10	0.024
A 9, A 12, A 16	MS 325	BEA 16/325	1SBN 081 406 R1001	10	0.031
A 26	MS 325	BEA 26/325	1SBN 082 406 R1001	10	0.031
A 30, A 40	MS 450	BEA 40/450	1SBN 083 206 R1000	1	0.061
A 50	MS 450	BEA 50/450	1SBN 083 506 R1000	1	0.062
A 50, A 63, A 75	MS 495	BEA 75/495	1SBN 084 106 R1000	1	0.120
A 95, A 110	MS 495	BEA 110/495	1SBN 084 506 R1000	1	0.124

Connection kit

I (A)	For manual motor starter	Type	Order code	Pack ^{ing} piece	Weight kg 1 piece
25 A	MS 325	BSA 325	FPTN 472 772 R0001	1	0.009

Mounting plates

For contactors	For manual motor starter	Type	Order code	Pack ^{ing} piece	Weight kg 1 piece
1 x A 26	MS 116 MS 325	PM 26-13	1SBN 092 406 R1000	2	0.160
2 x A 9 ... A 26	MS 116 MS 325	PM 26-23	1SBN 091 407 R1000	1	0.330

Connection sets for reversing contactors

Description

BER 16V, BER 16, BER 40V, BER 40
BEM 75-30 ... BEM 110-30

– 1 upstream and 1 downstream insulated, solid copper bars
– 3 upstream and 3 downstream insulated, solid copper bars

Note: For BER.. connection sets, Rated Insulation Voltage $U_i = 690$ V.

For reversing starters with interlock unit

Mounting on 3-pole contactors	Interlock unit type	Type	Order code	Pack ^{ing} piece	Weight kg 1 piece
2 x A 9 ... A 16	VM / VE 5-1	BER 16V	1SBN 081 411 R1000	1	0.045
2 x A 26	VM / VE 5-1	BER 40V	1SBN 082 411 R1000	1	0.085
2 x A 30, A 40					
2 x A 50 ... A 75	VE 5-2	BEM 75-30	1SBN 083 501 R1000	1	0.243
2 x A 95 ... A 110	VE 5-2	BEM 110-30	1SBN 084 301 R1000	1	0.450

Note: The connections provided for the A.. contactors can be used for the AF, AL, AL..Z, TAL, AE and TAE types.

For reversing starters without interlock unit

Mounting on 3-pole contactors	Type	Order code	Pack ^{ing} piece	Weight kg 1 piece
2 x A 9 ... A 16	BER 16	1SBN 081 411 R1001	1	0.040
2 x A 26	BER 40	1SBN 082 411 R1001	1	0.080
2 x A 30, A 40				

Note: The connections provided for the A.. contactors can be used for the AL, AL..Z and TAL types.

Connection Sets for Star-Delta Starters

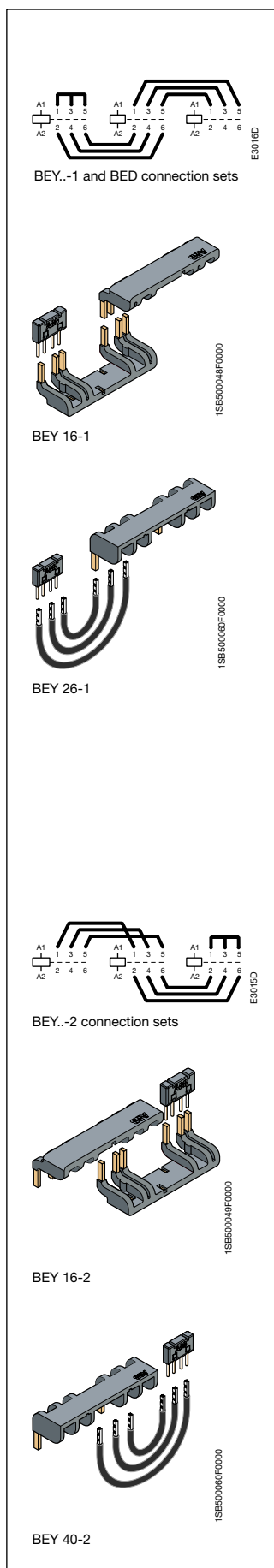

Description

- BEY 16..-1** – Insulated solid copper bars.
- BEY 26-1, BEY 40-1** – Insulated solid copper bars and insulated flexible copper wires.
- BED 50., BED 75., BED 95, BED 110** – Insulated solid copper bars.

These connection sets are designed for Star-Delta starters whose contactors are assembled according to **Star Delta Line** mounting. They are made up of:

- Star contactor: upstream Star point
- Star contactor / Delta contactor: downstream connection in parallel
- Delta contactor / Line contactor : upstream connection in parallel.

BEY 16-1, BED 50-1 and BED 75-1 connection sets are designed for star and delta contactors **without mechanical interlocking** (contactor mounting joined side by side). For **mechanically interlocked** star and delta contactors, use **BEY 16V-1, BED 50 and BED 75**.

BEY 26-1, BEY 40-1, BED 95 and BED 110 are designed for both star and delta contactors **with or without interlock unit**.

Note: For BEY.. connection sets, Rated Insulation Voltage $U_i = 690$ V.

Ordering Details

For contactor			Interlock unit type	Type	Order code	Pack ^{ing} piece	Weight kg
Star	Delta	Line					
A 9	A 9	A 9	–	BEY 16-1	1SBN 081 413 R1000	1	0.040
A 9	A 12	A 12	VE 5-1	BEY 16V-1	1SBN 081 413 R1001	1	0.045
A 12	A 16	A 16	–	BEY 26-1	1SBN 082 413 R1000	1	0.060
A 16	A 26	A 26	VE 5-1	BEY 26-1	1SBN 082 413 R1000	1	0.060
A 26	A 30	A 30	–	BEY 40-1	1SBN 082 813 R1000	1	0.060
A 26	A 40	A 40	VE 5-1	BEY 40-1	1SBN 082 813 R1000	1	0.060
A 30	A 50	A 50	–	BED 50-1	1SBN 083 503 R1001	1	0.180
A 40	A 63	A 63	VE 5-2	BED 50	1SBN 083 503 R1000	1	0.280
A 50	A 75	A 75	–	BED 75-1	1SBN 084 103 R1001	1	0.180
A 50	A 75	A 75	VE 5-2	BED 75	1SBN 084 103 R1000	1	0.250
A 75	A 95	A 95	–	BED 95	1SFN 084 303 R1000	1	0.400
A 75	A 95	A 95	VE 5-2	BED 95	1SFN 084 303 R1000	1	0.400
A 95	A 110	A 110	–	BED 110	1SFN 084 503 R1000	1	0.500
A 95	A 110	A 110	VE 5-2	BED 110	1SFN 084 503 R1000	1	0.500

Note: The connections provided for the A.. contactors can be used for the AL, AL..Z, AE and TAE types.

Variant for Star-Delta Starters 7.5 kW up to 37 kW - 400 V

- BEY 16..-2** – Insulated solid copper bars.
- BEY 26-2, BEY 40-2** – Insulated solid copper bars and insulated flexible copper wires

These connection sets are designed for Star-Delta starters whose contactors are assembled according to **Line Delta Star** mounting. They are made up of:

- Line contactor / Delta contactor: upstream connection phase-to-phase
- Delta contactor / Star contactor: downstream connection in parallel
- Star contactor: upstream Star point

BEY 16-2 connection set is designed for star and delta contactors **without mechanical interlocking** (contactor mounting joined side by side). For **mechanically interlocked** star and delta contactors, use **BEY 16V-2**.

BEY 26-2 and BEY 40-2 are designed for both star and delta contactors **with or without interlock unit** (contactor mounting joined side by side).

Note: For BEY.. connection sets, Rated Insulation Voltage $U_i = 690$ V.

Ordering Details

For contactor			Interlock unit type	Type	Order code	Pack ^{ing} piece	Weight kg
Line	Delta	Star					
A 9	A 9	A 9	–	BEY 16-2	1SBN 081 413 R2000	1	0.040
A 12	A 12	A 9	–	BEY 16V-2	1SBN 081 413 R2001	1	0.045
A 16	A 16	A 12	VE 5-1	BEY 16V-2	1SBN 081 413 R2001	1	0.045
A 26	A 26	A 16	–	BEY 26-2	1SBN 082 413 R2000	1	0.060
A 26	A 26	A 16	VE 5-1	BEY 26-2	1SBN 082 413 R2000	1	0.060
A 30	A 30	A 26	–	BEY 40-2	1SBN 082 813 R2000	1	0.060
A 40	A 40	A 26	VE 5-1	BEY 40-2	1SBN 082 813 R2000	1	0.060

Note: The connections provided for the A.. contactors can be used for the AL, AL..Z types.



ABB Entrelec

Export Department

10, rue Ampère Z.I. - B.P. 114
F-69685 Chassieu cedex / France
Tel. : +33 (0) 4 7222 1722
Fax : +33 (0) 4 7222 1935

As part of its on-going product improvement, ABB reserves the right to modify the characteristics or the products described in this document.
The information given is not-contractual. For further details please contact the ABB company marketing these products in your country.